

REALISTIC®

Service Manual

20-402

**PRO-2027
Programmable Scanner**

Catalog Number: 20-402

CONTENTS

	Page
Specifications	2
Block Diagram	3
Principles of Operation	4
General Operation Outline	6
Alignment/Adjustment	8
Reception Check	14
Memory Check	15
Troubleshooting	16
Printed Circuit Boards	18
Wiring Diagram	23
Electrical Parts List	25
Mechanical Parts List	44
Exploded View	45
Semiconductor Lead Identification and IC Block Diagram	46
Microprocessor (IC6) Port Format	53
Power Transformer Specifications	54
Schematic Diagram	55

© 1992 Tandy Corporation.
All Rights Reserved.

Radio Shack and Realistic are registered trademarks used by Tandy Corporation.

SPECIFICATIONS

Frequency Coverage	VHF Lo	30-54 MHz	5 kHz steps
	Aircraft	108-136.975 MHz	25 kHz steps
	VHF Hi	137-174 MHz	5 kHz steps
	UHF Lo	380-512 MHz	12.5 kHz steps
	UHF Hi	806.0000-823.9375 MHz	12.5 kHz steps
		851.0000-868.9375 MHz	12.5 kHz steps
		896.0000-960.0000 MHz	12.5 kHz steps
		Unit	Nominal Limit
Sensitivity	VHF Lo	μ V	0.5 2.0
	Aircraft	μ V	2.0 5.0
	VHF Hi	μ V	1.0 2.0
	UHF Lo	μ V	1.0 4.0
	UHF Hi	μ V	2.0 4.0
Squelch Sensitivity	at threshold	μ V	1 4
	at tight (Lo, Hi, UHF)	dB	25 15
	at tight (Aircraft)	dB	20 10
Selectivity	-6 dB	kHz	\pm 10 \pm 14
	-50 dB	kHz	\pm 20 \pm 25
Spurious Rejection	VHF Lo at 40 MHz	dB	50 40
	Aircraft at 124 MHz	dB	50 40
	VHF Hi at 154 MHz	dB	50 40
	UHF Lo at 450 MHz		Not specified
	UHF Hi at 860 MHz		Not specified
IF Rejection	10.7 MHz at 154 MHz	dB	50 40
Modulation Acceptance	(EIA RS-204-A)	kHz	\pm 8 15
Signal to Noise Ratio	VHF Lo at 40 MHz	dB	45 30
	Aircraft at 124 MHz	dB	35 25
	VHF Hi at 154 MHz	dB	45 30
	UHF Lo at 450 MHz	dB	35 25
	UHF Hi at 860 MHz	dB	35 25
Residual Noise	Vol. Min.	μ V	3 5
Scanning Speed	Fast Speed	channels/sec.	25 22-28
	Slow Speed	channels/sec.	8 7-9
Scan Delay Time		sec	2 1-3
Channels of Operation	Any 100 channels in any band combination		
Channel, Frequency, and Mode Display	Liquid Crystal Display		
Receiving System	Direct Key Entry Digital-Controlled Synthesizer, Superheterodyne 1st IF: 10.7 MHz, 2nd IF: 455 kHz		
Power Source	AC 120 volts, 60 Hz, 13 watts max.		
Dimensions	7 1/16 x 9 7/8 x 2 3/8 inches (DWH) (180 x 250 x 60 mm)		
Weight	Approx. 53 oz. (1.5kg) without antenna		

Note: Nominal specs represent the design specs. All units should be able to approximate these—some will exceed and some may drop slightly below these specs. Limit specs represent the absolute worst condition that still might be considered acceptable; in no case should a unit fail to meet limit specs.

BLOCK DIAGRAM

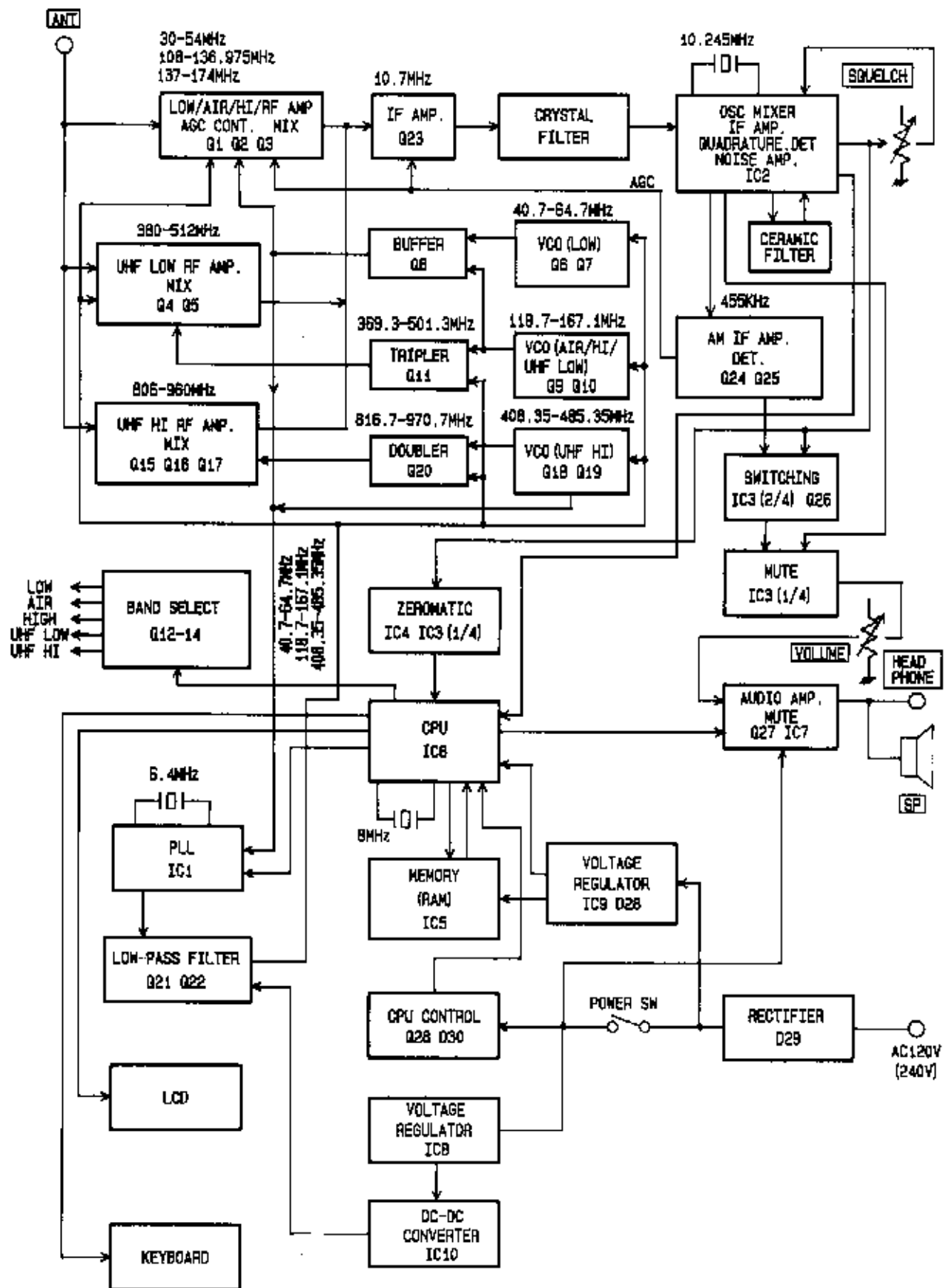

PRINCIPLES OF OPERATION

The PRO-2027 is a PLL (Phase Locked Loop) synthesized VHF/UHF, FM/AM receiver, controlled by a CPU (Central Processing Unit) via a keyboard.

The VHF Lo band (30-54 MHz) or VHF Hi band (137-174 MHz) is received in 5 kHz increments and the UHF Lo band (380-512 MHz) or UHF Hi band (808-960 MHz) is set up to be in 12.5 kHz increments. Similarly, the aircraft band (108-136.975 MHz) is in 25 kHz steps.

All functions, such as the receiving frequency range, frequency determination, and scanning and delay time, are controlled by the CPU. The CPU is able to do only the assigned functions and no modification of the CPU is feasible.

The following paragraphs explain the operation of the circuit in terms of the functional blocks:

Varactor (variable capacitance diode) tuning ("automatic tuning system") is employed on all bands.

Field-effect transistors (FET) are used in the RF/MIX circuits of low and high bands to achieve optimum mix-modulation and mutual-modulation characteristics. Q23 amplifies the 10.7 MHz IF. A 10.7 MHz monolithic crystal filter is incorporated to obtain a good IF selectivity.

IC2 contains the local oscillator, mixer, IF amplifier, quadrature FM detector, and noise amplifier. A crystal oscillator produces 10.245 MHz which is mixed with 10.7 MHz, resulting in 455 kHz IF. A 455 kHz ceramic filter is provided to increase the IF selectivity. The 455 kHz IF signal is amplified in the IF amp stage, and the quadrature FM detector detects it as an audio signal.

The detected output of the FM is applied to IC7. IC7 amplifies the audio signals and drives the speaker.

IC6 is the CPU, which does data processing and calculation. Any unstable supply voltage (VDD) to the CPU can cause CPU malfunctions, such as wrong data processing and wrong data transfer. To overcome this, C171 and R150 in the logic circuit "initialize" the CPU. (Refer to the schematic diagram on Page 55)

The initialization is done as soon as power is connected. Figure A shows the initializing waveform. The memory backup function is automatically started whenever the initialization has been done.

The RESET switch is located in the hole on the back of the unit and is used to correct an LCD or keyboard malfunction. Initialization of the CPU, as mentioned above, can also be done by pushing RESET.

Key input and receiving frequency are managed by the CPU, and the CPU output drives the LCD.

CX1 (8 MHz) is a ceramic oscillator which is used for CPU control. Figure B shows 1/8 divided of the waveform of Figure C.

IC6 Pin ①

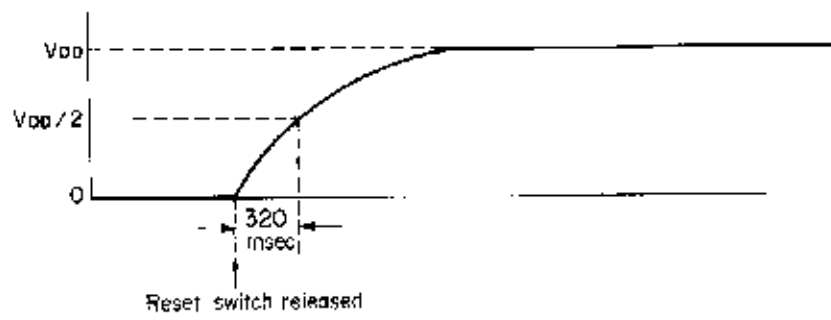

Figure A

IC6 Pin ⑧4

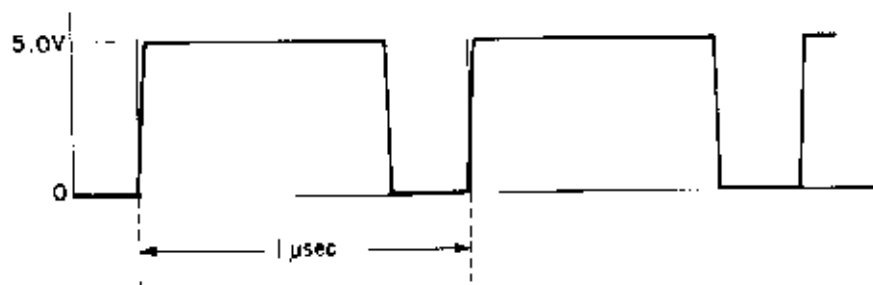

Figure B

IC6 Pin ⑤

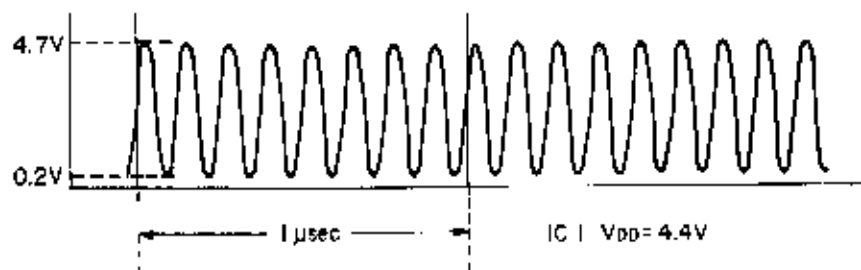
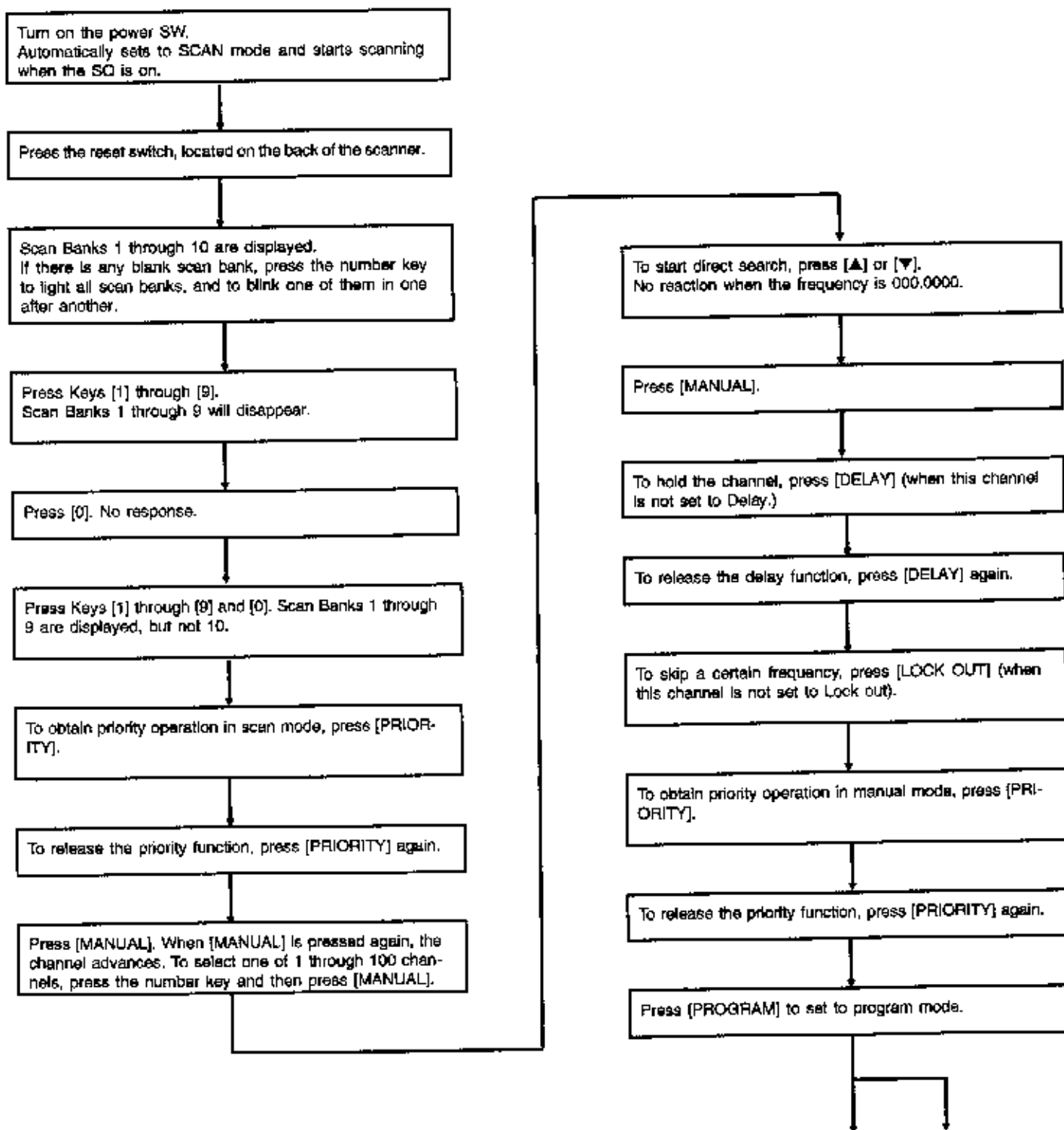
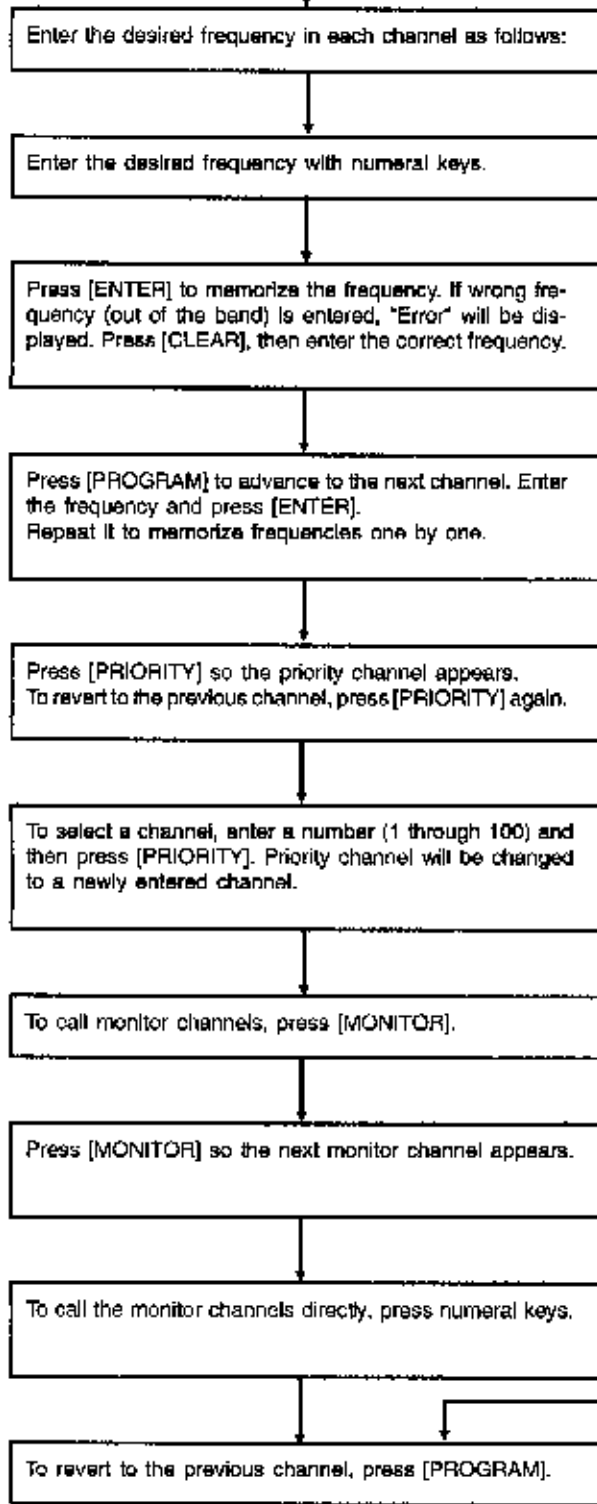

Figure C

GENERAL OPERATION OUTLINE



*1



*2

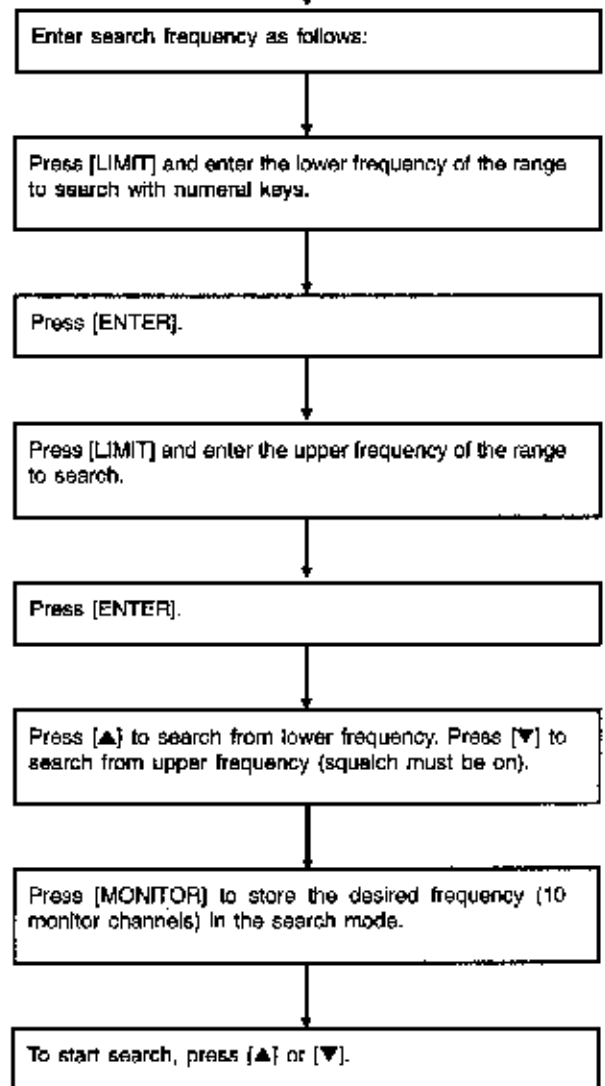

ALIGNMENT/ADJUSTMENT

Alignment and Test Point Locations

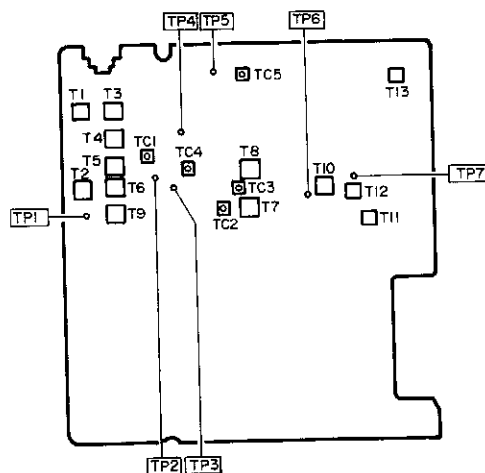

Alignment Preparation

Test equipment required:

1. Oscilloscope (0–500 kHz, 0–50 MHz)
2. AC SSVM
3. DC SSVM
4. Frequency counter (200 MHz)
5. Slow sweep generator with variable marker (10.7 MHz)
6. 8-ohm dummy load
7. VHF sweep generator with variable marker (30–54 MHz, 108–174 MHz)
8. UHF sweep generator with variable marker (380–512 MHz)
9. FM signal generator (30–54 MHz, 137–174 MHz, 380–512 MHz, 806–960 MHz)
10. AM signal generator (108–136.975 MHz)

Notes:

- Use non-metallic tuning tools.
- The test equipment and receiver should be warmed up for at least 10 minutes before proceeding with alignment.
- The signal level from the generator should be kept as low as possible to obtain an usable output.
- The memory backup circuit can hold the programmed channel memories for about one hour, or until the power is provided (within one hour).

Program Channel 1 to Channel 15 as follows:

Channel	Frequency (MHz)	Channel	Frequency (MHz)
1	30.0000	9	174.0000
2	41.0050	10	380.0000
3	54.0000	11	451.0000
4	108.1000	12	512.0000
5	121.0000	13	806.0000
6	136.9750	14	908.0875
7	137.0000	15	960.0000
8	155.0000		

Table 1

ALIGNMENT PROCEDURES

Reference Frequency OSC Alignment

Step	Control Setting	Test Instrument Connection	Adjust	Remarks
1	OFF/VOLUME control: ON. SQUELCH control: Fully counterclockwise (CCW). Select Channel 4.	Connect frequency counter to TP3 and GND. See Figure 1.	TC5	Adjust TC5 so the frequency is 118.800000 MHz \pm 10 Hz.

IF Section Alignment

Step	Control Setting	Test Instrument Connection	Adjust	Remarks
2	OFF/VOLUME control: ON. SQUELCH control: CCW.	Connect test instruments as shown in Fig. 2.	T9 T10	Adjust T9 for maximum RF waveform and adjust T10 to make the left and the right of the S curve symmetrical.

Note: During alignment, maintain the sweep generator output at the lowest level to prevent overloading.

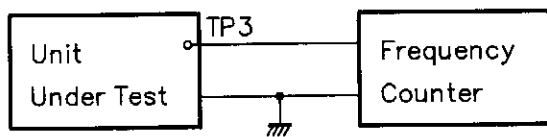

Figure 1

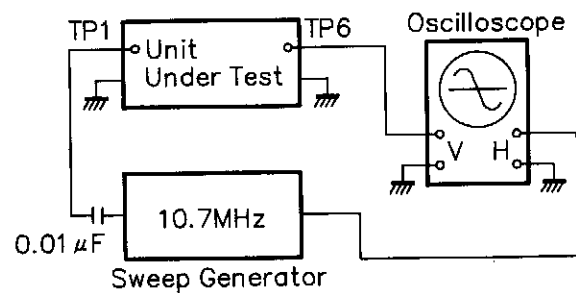

Figure 2

VCO Alignment

VHF Lo Band

Step	Control Setting	Test Instrument Connection	Adjust	Remarks
3	OFF/VOLUME control: ON. SQUELCH control: CCW. Select Channels 1 through 3.	Connect DC SSVM to TP5 and GND. See Figure 3.	TC2 T7	1) Select Channel 3 and adjust TC2 for 13 volts on the DC SSVM. 2) Select Channel 1 and adjust T7 for 1.0 volt on the DC SSVM. 3) Repeat Steps 1) and 2) until no further improvement is observed. See Table 2.

CH	Frequency	Voltage
CH1	30 MHz	Voltage at TP5 0.9–1.1 volts
CH2	41.005 MHz	Voltage at TP5 4.0–5.3 volts
CH3	54 MHz	Voltage at TP5 12.9–13.1 volts

Table 2

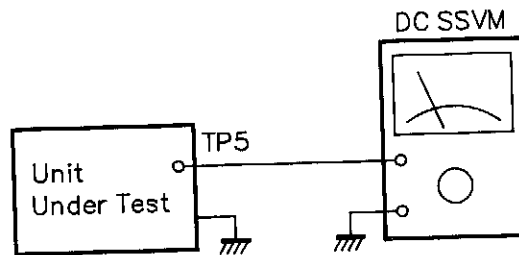

Figure 3

VHF Hi Aircraft, and UHF Lo Bands

Step	Control Setting	Test Instrument Connection	Adjust	Remarks
4	OFF/VOLUME control: ON. SQUELCH control: CCW. Select Channels 4 through 12.	Connect DC SSVM to TP5 and GND. See Figure 3.	TC3 T8	1) Select Channel 12 and adjust TC3 for 12.0 volts on the DC SSVM. 2) Select Channel 4 and adjust T8 for 1.0 volt on the DC SSVM. 3) Repeat Steps 1) and 2) until no improvement is observed. See Table 3.

CH	Frequency	Voltage
CH4	108.100 MHz	Voltage at TP5 0.9-1.1 volts
CH5	121.000 MHz	Voltage at TP5 2.5-3.5 volts
CH6	136.975 MHz	Voltage at TP5 5.5-6.5 volts
CH7	137.000 MHz	Voltage at TP5 1.5-2.5 volts
CH8	155.000 MHz	Voltage at TP5 5.0-6.5 volts
CH9	174.000 MHz	Voltage at TP5 10.0-11.5 volts
CH10	380.000 MHz	Voltage at TP5 1.5-2.5 volts
CH11	451.000 MHz	Voltage at TP5 5.5-6.5 volts
CH12	512.000 MHz	Voltage at TP5 11.9-12.1 volts

Table 3

UHF Hi Band

Step	Control Setting	Test Instrument Connection	Adjust	Remarks
5	OFF/VOLUME control: ON. SQUELCH control: CCW. Select Channel 15.	Connect DC SSVM to TP5 and GND. See Figure 3.	L13	Adjust L13 for 11.0 volts on the DC SSVM. See Table 4.

CH	Frequency	Voltage
CH13	806.000 MHz	Voltage at TP5 4.5-5.5 volts
CH14	908.0875 MHz	Voltage at TP5 8.5-9.5 volts
CH15	960.0000 MHz	Voltage at TP5 10.9-11.1 volts

Table 4

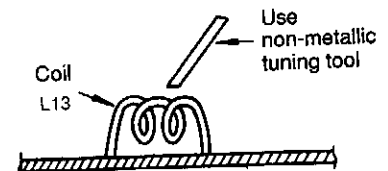

Figure 4

Note: Be very careful when doing internal alignment of Coil L13 as shown in Figure 4 because it may affect frequency greatly.

Secure the coil with glue after alignment and then repeat Step 5 above after checking that the coil is secure and the temperature is normal.

RF Amp. Alignment

VHF Lo Band

Step	Control Setting	Test Instruments Connection	Adjust	Remarks
6	OFF/VOLUME control: ON. SQUELCH control: CCW. Select Channels 1 through 3. See Table 1.	Connect instruments shown as in Figure 5. Sweep generator 30-54 MHz.	T1 T2	1) Select Channel 2 and adjust T1 and T2 for maximum RF waveform. 2) Check Channels 1 through 3 for maximum output. A slight deviation as shown in Figure 6 is acceptable.

VHF AIR Band

Step	Control Setting	Test Instruments Connection	Adjust	Remarks
7	OFF/VOLUME control: ON. SQUELCH control: CCW. Select Channels 4 through 6. See Table 1.	Same as Step 6. Sweep generator 108.1-136.975 MHz.	T3 T5	1) Select Channel 5 and adjust T3 and T5 for maximum RF output. 2) Check Channels 4 through 6 for maximum RF output. A slight deviation as shown in Figure 7 is acceptable.

VHF Hi Band

Step	Control Setting	Test Instrument	Adjust	Remarks
8	OFF/VOLUME control: ON. SQUELCH control: CCW. Select Channels 7 through 9. See Table 1.	Same connection as Step 6. Sweep generator 137-174 MHz.	T4 T6	1) Select Channel 7 and adjust T4 and T6 for maximum RF waveform. 2) Check Channels 7 through 9 for maximum RF output. A slight deviation as shown in Figure 8 is acceptable.

UHF Lo Band

Step	Control Setting	Test Instrument	Adjust	Remarks
9	OFF/VOLUME control: ON. SQUELCH control: CCW. Select Channels 10 through 12. See Table 1.	Same connection as Step 6. Sweep generator 380-512 MHz.	TC1 TC4	1) Select Channel 10 and adjust TC1 and TC4 for maximum RF output. 2) Check Channels 10 through 12 for maximum RF output. A slight deviation as shown in Figure 9 is acceptable.

UHF Hi Band: No adjustment required.

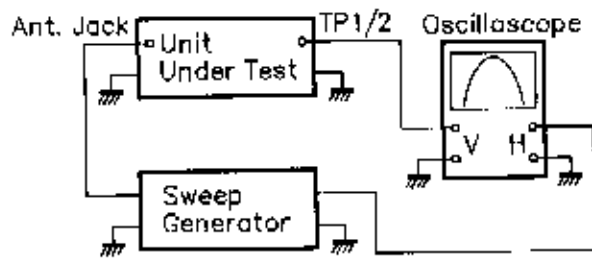

Figure 5

Notes:

- Use TP1 for VHF Lo, Aircraft, and VHF Hi band adjustments.
- Use TP2 for UHF Lo band adjustment.

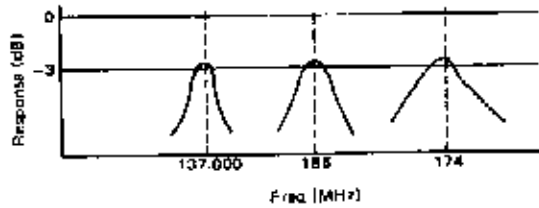

Figure 6

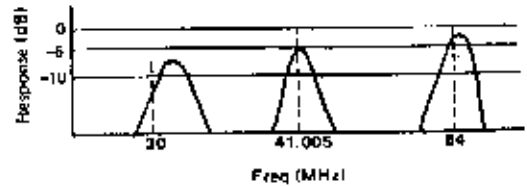

Figure 8

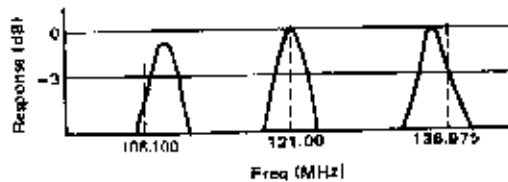

Figure 7

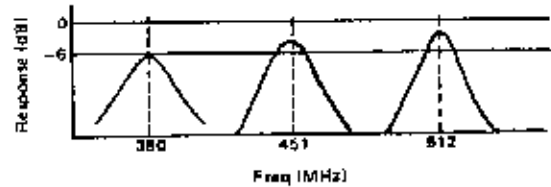

Figure 9

Overall Alignment and Sensitivity Measurement

Step	Control Setting	Test Instrument Connection	Adjust	Remarks
10	OFF/VOLUME control: ON. SQUELCH control: CCW. Select Channel 5.	Short-circuit the resistor R301 (270 ohm, 1/2 W) on the headphone PCB with a jumper wire as shown in Figure 10 and connect the AM signal generator to the ANT jack and the AC SSVM to the headphone jack across an 8-ohm dummy load as shown in Figure 12.	T9 T11 T12	1) Adjust T9 and T11 for maximum output at the S/N ratio 20 dB. 2) Adjust T12 for minimum THD.

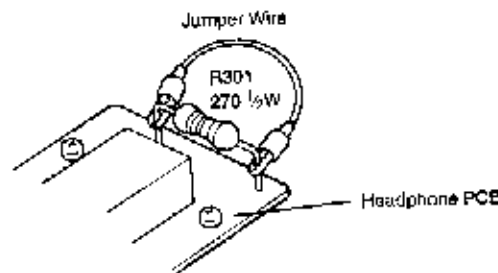

Figure 10

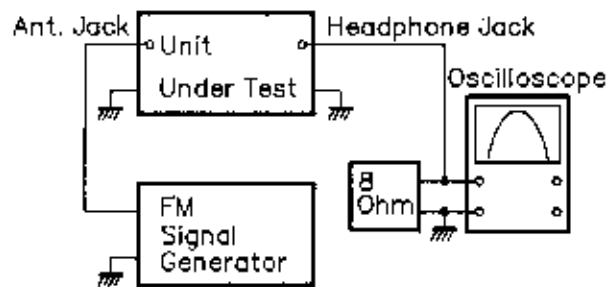

Figure 11

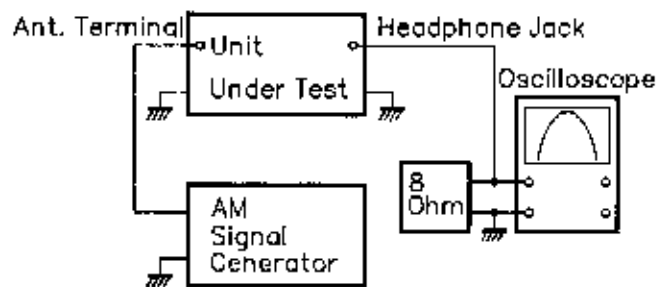
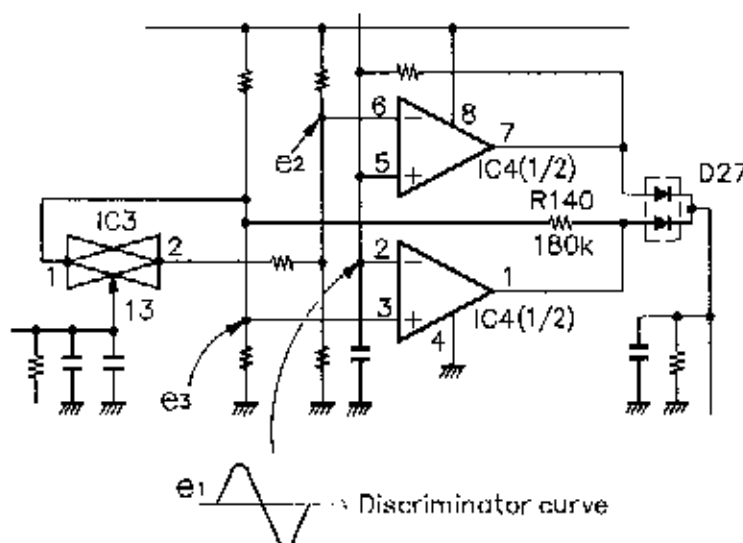

Figure 12

Note: TP7 is used to observe the AM band detector output.

Step	Control Setting	Test Instrument Connection	Remarks
11	OFF/VOLUME control: ON SQUELCH control: CCW Channel as Table 1.	Connect the FM signal generator to the ANT jack and the AC SSVM to the headphone jack across an 8ohm dummy load. See Figures 10 and 11. Set the signal generator to each frequency as shown in Table 1. Set the Volume control for 0 dB (0.775 V) reading on the SSVM.	Turn off the modulation and measure the (S+N)/N ratio.

Zeromatic Function Test Procedure



(Zeromatic functions when OUTPUT is low (L).

	$0 < e1 < e3$	$e3 < e1 < e2$	$e2 < e1 < V_{cc}$
OUTPUT (D27 Cathode)	H	L	H

To adjust the $e1$ voltage, receive a signal in the manual mode, and set T10 to obtain 2.0 V at TP6. It is convenient to use the National Weather Service Signal for the adjustment.

If Zeromatic does not function correctly, refer to the Reference Frequency OSC Alignment (Page 9), check $118.800000 \text{ MHz} \pm 10\text{Hz}$, and adjust T10 again to 2.0 VDC while a signal is being received.

RECEPTION CHECK

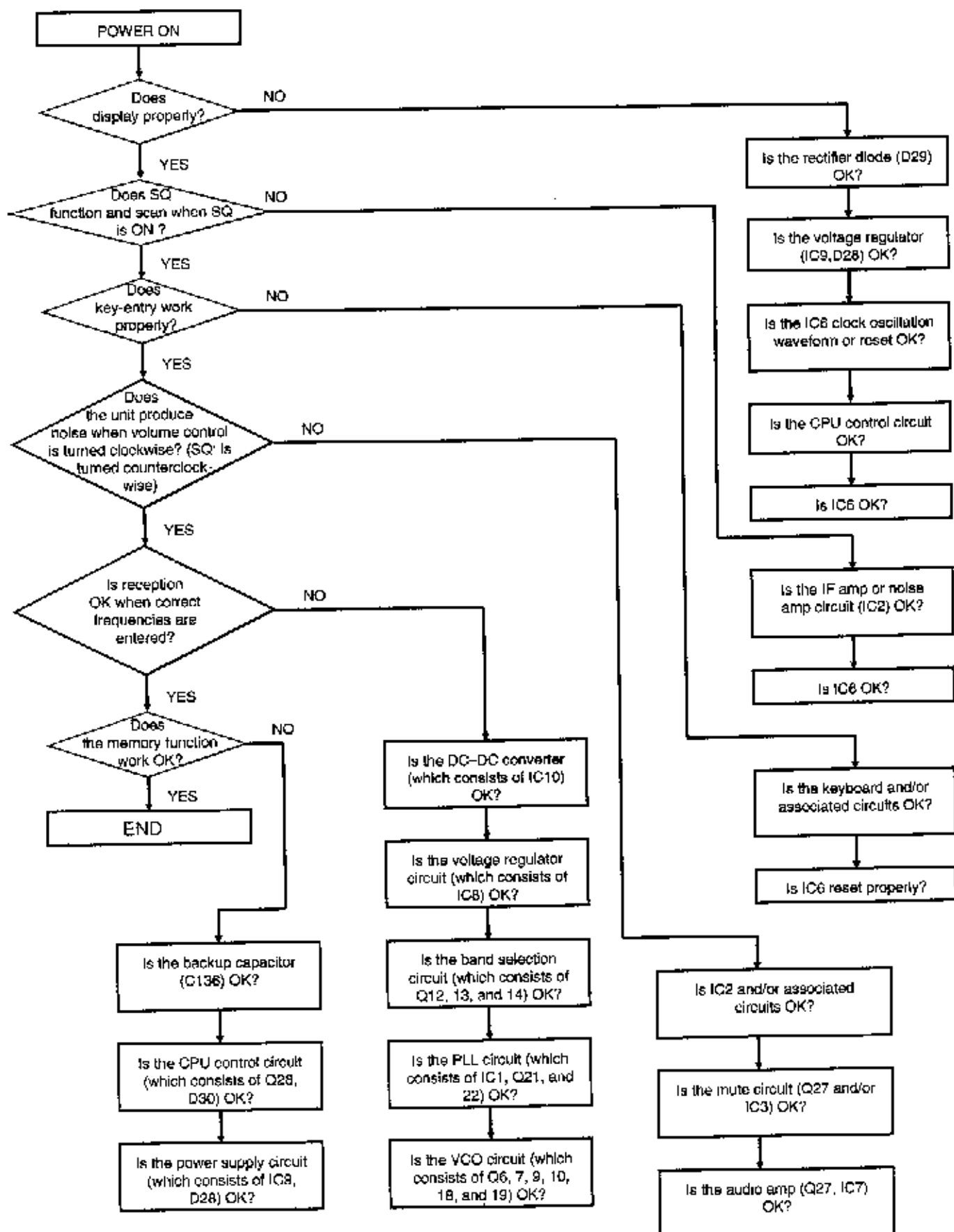

MEMORY CHECK

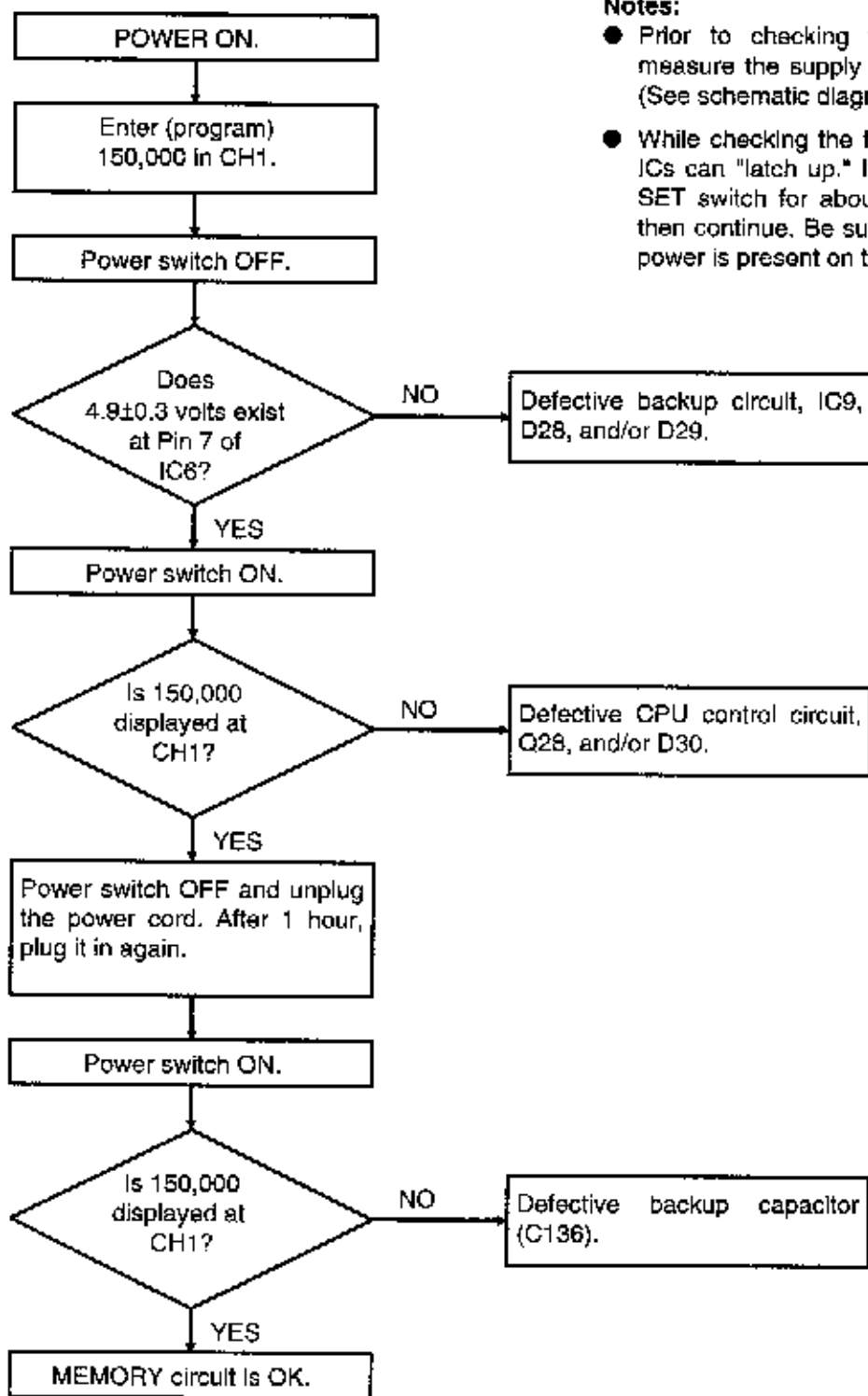

Notes:

- Prior to checking the CPU system, measure the supply voltage to the ICs. (See schematic diagram.)
- While checking the following items, the ICs can "latch up." If so, push the RESET switch for about one second and then continue. Be sure that the external power is present on this check.

TROUBLESHOOTING

Symptom	Cause/Remedy
Display does not light and there is no sound when POWER is on. Volume control: MAX. Squelch control counterclockwise (CCW).	<ol style="list-style-type: none"> 1. Defective power cord: Replace. 2. Defective ON-OFF switch on volume control: Replace.
Display lights but there is no sound. Volume control: MAX. Squelch control: CCW.	<ol style="list-style-type: none"> 1. Defective speaker : Replace the defective parts. 2. Defective audio amplifier IC7 and/or associated circuit components: Replace the defective components. 3. Defective IF amplifier IC2 and/or associated circuit components: Replace the defective components. 4. Defective functional squelch control and/or associated circuit components: Replace the defective components. 5. Defective Q27, IC3, and/or associated circuit: Replace the defective components.
Sound comes out but display does not light. Volume control: MAX. Squelch control: CCW.	<ol style="list-style-type: none"> 1. Defective LCD: Replace the defective components. 2. Defective IC6 and/or associated circuit: Replace the defective components.
Does not scan and squelch does not operate.	<ol style="list-style-type: none"> 1. Defective IC2 and/or associated circuit components: Replace the defective components. 2. Defective IC6 and/or associated circuit components: Replace the defective components.
Does not scan but squelch operates.	Defective IC6 and/or associated circuit components: Replace the defective components.
Displays incorrectly and/or unable to enter correctly when RESET switch is pushed.	<ol style="list-style-type: none"> 1. Defective keyboard and/or associated circuit: Replace the defective components. 2. Defective CPU (IC6) and/or associated circuit: Replace the defective components.
Displays correctly at the time of programming, but after scanning, it becomes faulty.	Defective CPU (IC6) and/or associated circuit: Replace the defective components.
MANUAL select operates, but SCAN does not operate.	Squelch control is not adjusted correctly: Turn squelch control clockwise.
All bands do not operate, but display is OK.	<ol style="list-style-type: none"> 1. Defective Q21 and Q22 in low-pass filter: Replace the defective components. 2. Defective IC1 and/or associated circuit: Replace the defective components. 3. Defective IC8 voltage regulator and/or IC10 DC-DC converter circuit: Replace the defective components.

Symptom	Cause/Remedy
VHF Lo (Mid) band does not operate, but Aircraft, VHF Hi, UHF Lo, and UHF Hi bands operate.	<ol style="list-style-type: none"> 1. Defective D1, D2, T1, T2 tuning circuit and/or Q6, Q7 VCO circuit: Replace the defective components. 2. Defective Q14 and/or associated circuit: Replace the defective components.
Aircraft band does not operate, but VHF Lo, VHF Hi, UHF Lo, and UHF Hi bands operate.	<ol style="list-style-type: none"> 1. Defective D8, T3, T5, and/or associated circuit: Replace the defective components. 2. Defective AM IF Amp., including Q24 and Q25: Replace the defective components. 3. Defective Q14 in band switch circuit: Replace the defective components.
VHF Hi band does not operate but VHF Lo, Aircraft, UHF Lo, and UHF Hi bands operate.	<ol style="list-style-type: none"> 1. Defective D3, D9, T4, T6, and/or associated circuit: Replace the defective components. 2. Defective Q13 in band switch circuit: Replace the defective components.
UHF Lo band does not operate, but VHF Lo, Aircraft, VHF Hi, and UHF Hi bands operate.	<ol style="list-style-type: none"> 1. Defective Q4, Q5, and/or associated circuit: Replace the defective components. 2. Defective Q12 in band switch circuit: Replace the defective components.
UHF Hi band does not operate, but VHF Lo, Aircraft, VHF Hi, and UHF Lo bands operate.	<ol style="list-style-type: none"> 1. Defective Q15-17, Q20, and/or associated circuit: Replace the defective components. 2. Defective Q18, Q19 VCO circuit: Replace the defective components. 3. Defective Q12 and/or associated circuit: Replace the defective components.
"Zeromatic" does not operate or holds on a drifted frequency during search operation.	<ol style="list-style-type: none"> 1. Defective IC3, IC4, and D27 in Zeromatic circuit: Replace the defective components. 2. Discriminator coil is out of adjustment: TP6 shall have approximately 2.0 V in normal receiving mode. Refer to "Reference Frequency OSC Alignment" on Page 9.

Note:

Pulses generated while checking circuits and/or certain combinations of key operation may cause improper operation. To clear malfunctions, re-initialize the CPU : Push the RESET switch while pressing CLEAR, and then release the RESET switch. All channels (100 ch) will be cleared and the frequency indicator displays 000.0000. (Be sure the power is on while re-initializing the CPU.)

PRINTED CIRCUIT BOARDS

HEADPHONE JACK PCB

(Top View)

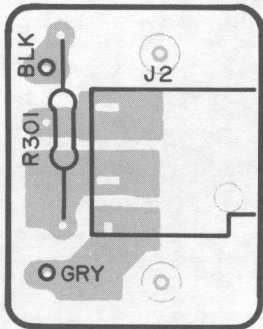

(Bottom View)

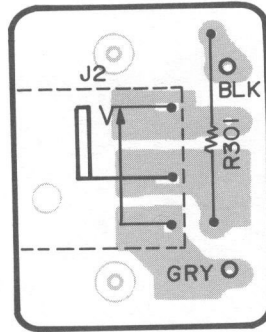

VOLUME PCB

(Top View)

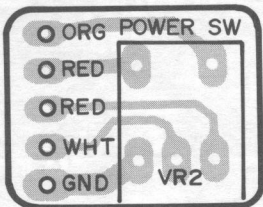

(Bottom View)

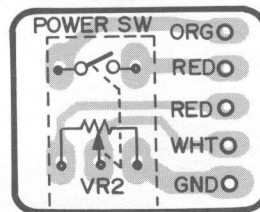

SQUELCH PCB

(Top View)

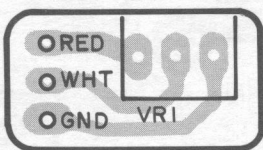

(Bottom View)

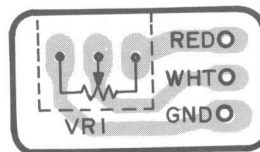

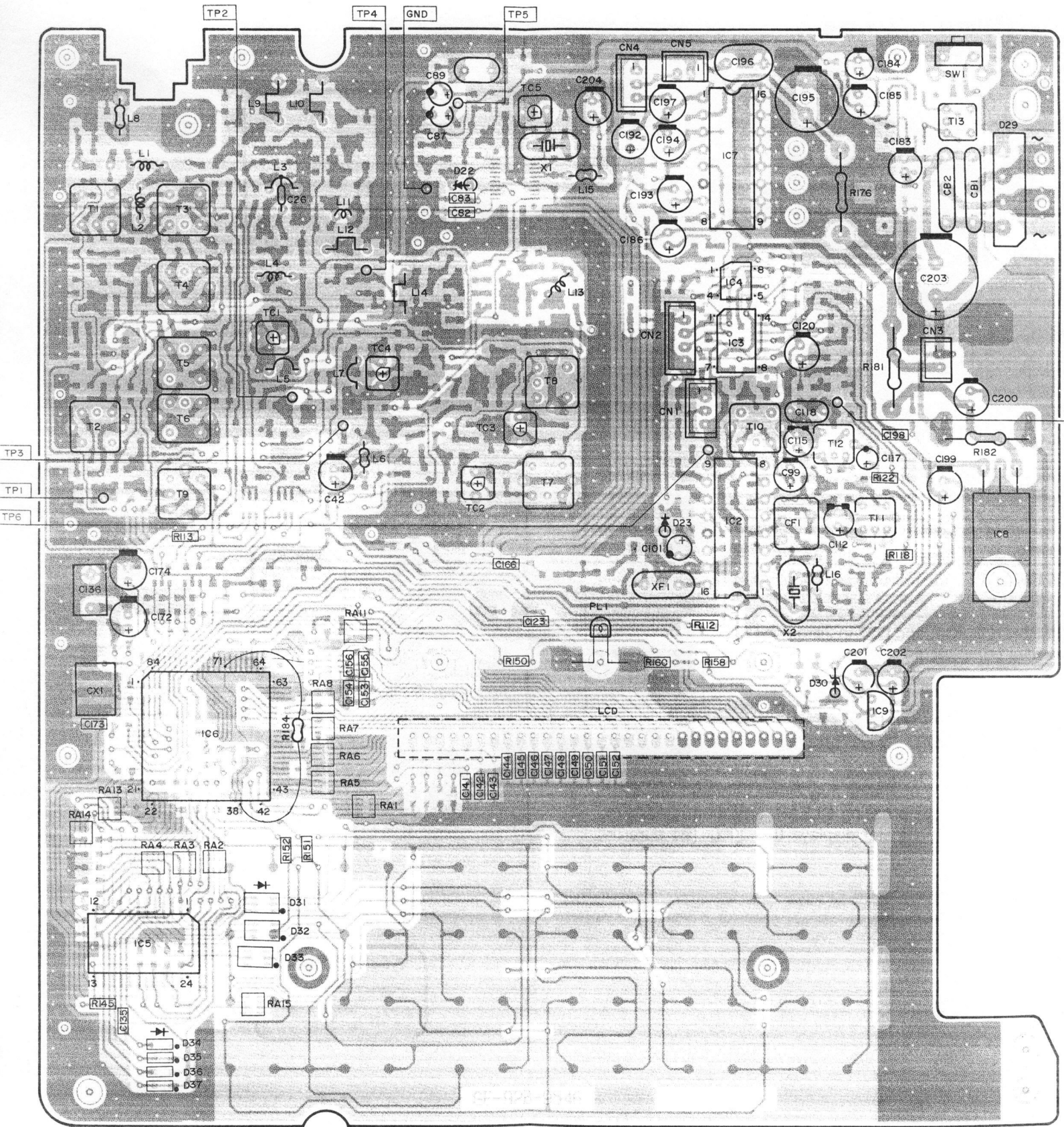

PC BOARD
Bottom

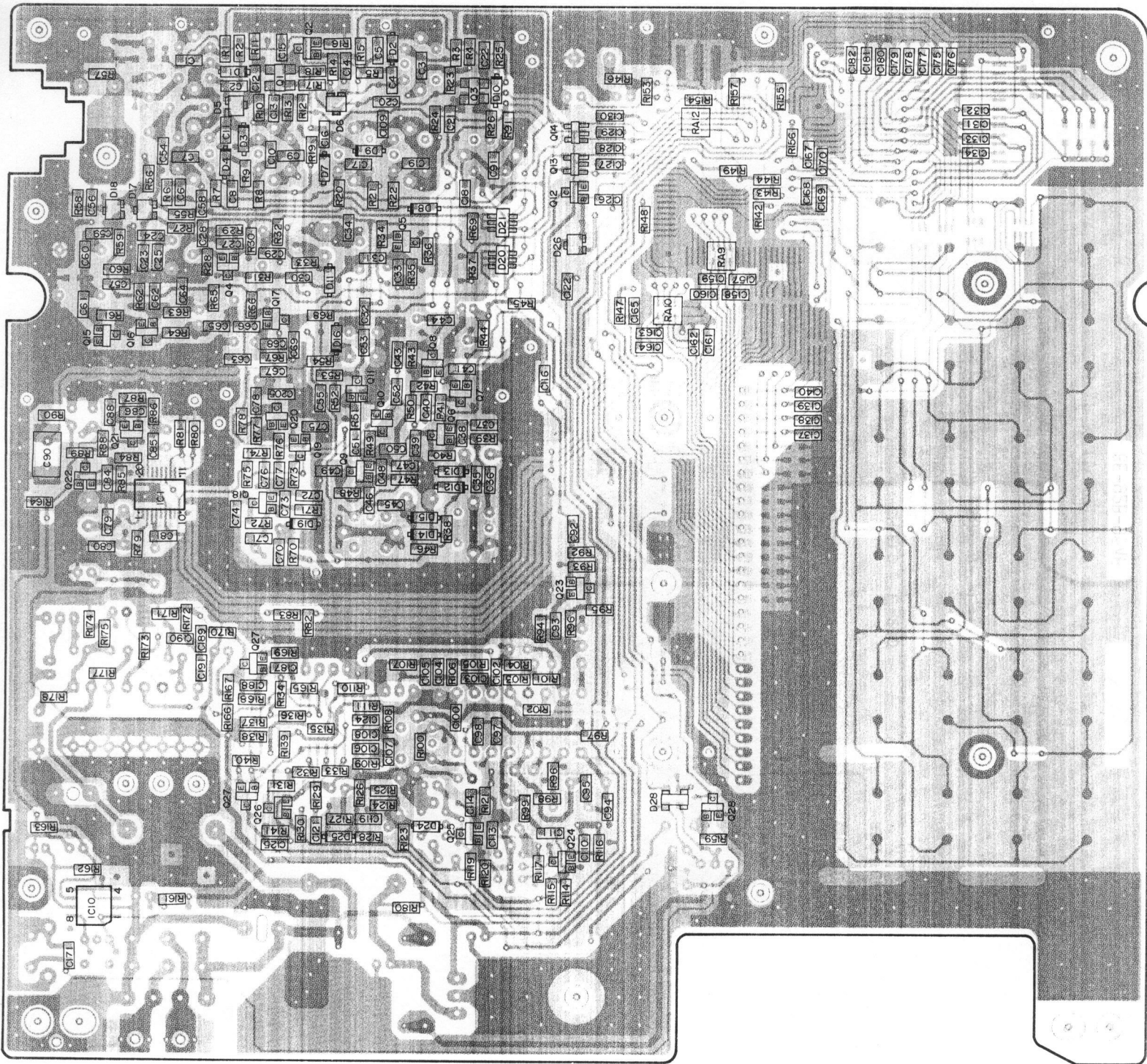

PHONE JACK

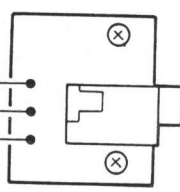

ANT. JACK

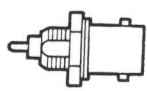

Wiring Diagram

SPEAKER

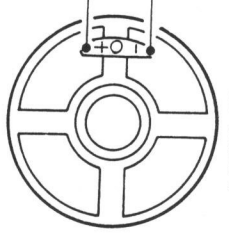

TRANSFORMER

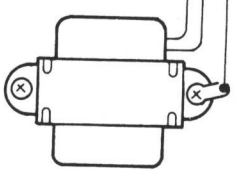

GROUND PLATE

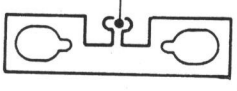

VOLUME CONTROL



SQUELCH CONTROL

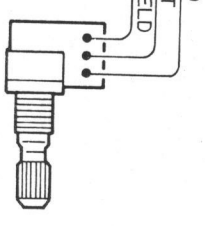

BLK L=175
BLU L=175

BLK L=125

BLU
BLU

BLK L=215

ORG L=230
RED L=230

SHIELD L=240
SHIELD L=180

BLK L=270
WHT L=270
GRY L=270

BLU
BLK

SHIELD
WHT
BLK
SHIELD
RED
WHT

SHIELD
WHT
BLK
SHIELD
RED
WHT

ELECTRICAL PARTS LIST

HEADPHONE JACK PCB ASSEMBLY

Ref. No.	Description	RS Part No.	Mfr's Part No.
③0	Assembly, PCB, Headphone Jack Consists of the following:		GA-92D-9751
Resistors			
R301	Carbon Film 270 ohm 1/2 W ±5%		ERD50FJ271P
Miscellaneous			
J2	Jack, Headphone		MOJ-B21M

MAIN PCB ASSEMBLY

Ref. No.	Description	RS Part No.	Mfr's Part No.
	Assembly, PCB, Main		GA-92D-9748
(31)	Consists of the following:		
Capacitors			
C1	Ceramic 0.01 μ F 50 V \pm 10%	0805	CC20B1H103K
C2	Ceramic 0.001 μ F 50 V \pm 5%	0805	CC20SL1H102J
C3	Ceramic 0.01 μ F 50 V \pm 10%	0805	CC20B1H103K
C4	Ceramic 0.001 μ F 50 V \pm 5%	0805	CC20SL1H102J
C5	Ceramic 0.001 μ F 50 V \pm 5%	0805	CC20SL1H102J
C6	Ceramic 0.001 μ F 50 V \pm 5%	0805	CC20SL1H102J
C7	Ceramic 0.001 μ F 50 V \pm 5%	0805	CC20SL1H102J
C8	Ceramic 0.001 μ F 50 V \pm 5%	0805	CC20SL1H102J
C9	Ceramic 0.001 μ F 50 V \pm 5%	0805	CC20SL1H102J
C10	Ceramic 3 pF 50 V \pm 0.25 pF	0805	CC20SL1H030C
C11	Ceramic 0.001 μ F 50 V \pm 5%	0805	CC20SL1H102J
C12	Ceramic 22 pF 50 V \pm 10%	0805	CC20SL1H220K
C13	Ceramic 0.001 μ F 50 V \pm 5%	0805	CC20SL1H102J
C14	Ceramic 0.001 μ F 50 V \pm 5%	0805	CC20SL1H102J
C15	Ceramic 0.001 μ F 50 V \pm 5%	0805	CC20SL1H102J
C16	Ceramic 0.001 μ F 50 V \pm 5%	0805	CC20SL1H102J
C17	Ceramic 0.001 μ F 50 V \pm 5%	0805	CC20SL1H102J
C18	Ceramic 0.001 μ F 50 V \pm 5%	0805	CC20SL1H102J
C19	Ceramic 0.001 μ F 50 V \pm 5%	0805	CC20SL1H102J
C20	Ceramic 10 pF 50 V \pm 0.5 pF	0805	CC20SL1H100D
C21	Ceramic 100 pF 50 V \pm 10%	0805	CC20SL1H101K
C22	Ceramic 0.001 μ F 50 V \pm 5%	0805	CC20SL1H102J
C23	Ceramic 2 pF 50 V \pm 0.25 pF	0805	CC20SL1H020C
C24	Ceramic 6 pF 50 V \pm 0.5 pF	0805	CC20SL1H060D
C25	Ceramic 8 pF 50 V \pm 0.5 pF	0805	CC20SL1H080D
C26	Ceramic 10 pF 50 V \pm 0.5 pF	0805	HE40SJSL100D
C27	Ceramic 100 pF 50 V \pm 10%	0805	CC20SL1H101K
C28	Ceramic 0.001 μ F 50 V \pm 5%	0805	CC20SL1H102J
C29	Ceramic 0.001 μ F 50 V \pm 5%	0805	CC20SL1H102J
C30	Ceramic 10 pF 50 V \pm 0.5 pF	0805	CC20SL1H100D
C31	Ceramic 10 pF 50 V \pm 0.5 pF	0805	CC20SL1H100D
C32	Ceramic 1 pF 50 V \pm 0.25 pF	0805	CC20SL1H010C
C33	Ceramic 0.001 μ F 50 V \pm 5%	0805	CC20SL1H102J
C34	Ceramic 0.001 μ F 50 V \pm 5%	0805	CC20SL1H102J
C35	Ceramic 0.001 μ F 50 V \pm 5%	0805	CC20SL1H680K
C36	Ceramic 68 pF 50 V \pm 10%	0805	CC20SL1H580K
C37	Ceramic 58 pF 50 V \pm 10%	0805	CC20SL1H680K
C38	Ceramic 68 pF 50 V \pm 10%	0805	CC20SL1H102J
C39	Ceramic 0.001 μ F 50 V \pm 5%	0805	CC20SL1H050C
C40	Ceramic 5 pF 50 V \pm 0.25 pF	0805	CC20SL1H102J
C41	Ceramic 0.001 μ F 50 V \pm 5%	0805	16UTSS470M
C42	Electrolytic 47 μ F 16 V \pm 20%		or SM16V470M
C43	Ceramic 470 pF 50 V \pm 10%	0805	CC20SL1H471K
C44	Ceramic 10 pF 50 V \pm 0.5 pF	0805	CC20SL1H100D
C45	Ceramic 220 pF 50 V \pm 10%	0805	CC20SL1H221K

Ref. No.	Description					RS Part No.	Mfr's Part No.
C46	Ceramic	100 pF	50 V	±10%	0805		CC20SL1H101K
C47	Ceramic	22 pF	50 V	±10%	0805		CC20SL1H220K
C48	Ceramic	22 pF	50 V	±10%	0805		CC20SL1H220K
C49	Ceramic	0.001 μF	50 V	±5%	0805		CC20SL1H102J
C50	Ceramic	5 pF	50 V	±0.25 pF	0805		CC20SL1H050C
C51	Ceramic	10 pF	50 V	±0.5 pF	0805		CC20SL1H100D
C52	Ceramic	0.001 μF	50 V	±5%	0805		CC20SL1H102J
C53	Ceramic	10 pF	50 V	±0.5 pF	0805		CC20SL1H100D
C54	Ceramic	0.001 μF	50 V	±5%	0805		CC20SL1H102J
C55	Ceramic	0.001 μF	50 V	±5%	0805		CC20SL1H102J
C56	Ceramic	0.001 μF	50 V	±5%	0805		CC20SL1H102J
C57	Ceramic	0.001 μF	50 V	±5%	0805		CC20SL1H102J
C58	Ceramic	0.001 μF	50 V	±5%	0805		CC20SL1H102J
C59	Ceramic	3 pF	50 V	±0.25 pF	0805		CC20SL1H030C
C60	Ceramic	1.5 pF	50 V	±0.25 pF	0805		CC20SL1H1R5C
C61	Ceramic	2 pF	50 V	±0.25 pF	0805		CC20SL1H020C
C62	Ceramic	33 pF	50 V	±10%	0805		CC20SL1H330K
C63	Ceramic	0.001 μF	50 V	±5%	0805		CC20SL1H102J
C64	Ceramic	33 pF	50 V	±10%	0805		CC20SL1H330K
C65	Ceramic	1.5 pF	50 V	±0.25 pF	0805		CC20SL1H1R5C
C66	Ceramic	3 pF	50 V	±0.25 pF	0805		CC20SL1H030C
C67	Ceramic	1 pF	50 V	±0.25 pF	0805		CC20SL1H010C
C68	Ceramic	1 pF	50 V	±0.25 pF	0805		CC20SL1H010C
C69	Ceramic	5 pF	50 V	±0.25 pF	0805		CC20SL1H050C
C70	Ceramic	2 pF	50 V	±0.25 pF	0805		CC20SL1H020C
C71	Ceramic	100 pF	50 V	±10%	0805		CC20SL1H101K
C72	Ceramic	10 pF	50 V	±0.5 pF	0805		CC20SL1H100D
C73	Ceramic	12 pF	50 V	±10%	0805		CC20SL1H120K
C74	Ceramic	0.001 μF	50 V	±5%	0805		CC20SL1H102J
C75	Ceramic	0.001 μF	50 V	±5%	0805		CC20SL1H102J
C76	Ceramic	5 pF	50 V	±0.25 pF	0805		CC20SL1H050C
C77	Ceramic	5 pF	50 V	±0.25 pF	0805		CC20SL1H050C
C78	Ceramic	3 pF	50 V	±0.25 pF	0805		CC20SL1H030C
C79	Ceramic	39 pF	50 V	±10%	0805		CC20UJ1H390K
C80	Ceramic	56 pF	50 V	±10%	0805		CC20UJ1H560K
C81	Ceramic	0.01 μF	50 V	±10%	0805		CC20B1H103K
C82	Ceramic	100 pF	50 V	±10%	0805		CC20SL1H101K
C83	Ceramic	100 pF	50 V	±10%	0805		CC20SL1H101K
C84	Ceramic	10 pF	50 V	±0.5 pF	0805		CC20SL1H100D
C85	Ceramic	0.0047 μF	50 V	±10%	0805		CC20B1H472K
C86	Ceramic	47 pF	50 V	±10%	0805		CC20SL1H470K
C87	Tantalum	2.2 μF	25 V	±20%			TSD-A1E2R2M
C88	Ceramic	0.01 μF	50 V	±10%	0805		CC20B1H103K
C89	Tantalum	0.1 μF	35 V	±20%			DN1V0R1M1S
C90	*Mylar	0.022 μF	50 V	±10%			NNM-223K
C91	Ceramic	0.01 μF	50 V	±10%	0805		CC20B1H103K
C92	Ceramic	0.001 μF	50 V	±5%	0805		CC20SL1H102J
C93	Ceramic	0.01 μF	50 V	±10%	0805		CC20B1H103K

*Mylar is a registered trademark of E. I. Du Pont de Nemours and Company.

Ref. No.	Description					RS Part No.	Mfr's Part No.
C94	Ceramic	120 pF	50 V	±10%	0805		CC20SL1H121K
C95	Ceramic	180 pF	50 V	±10%	0805		CC20SL1H181K
C96	Ceramic	22 pF	50 V	±10%	0805		CC20SL1H220K
C97	Ceramic	0.082 μF	25 V	±10%	0805		CC20B1E823K or GRM40B823K25
C98	Ceramic	0.082 μF	25 V	±10%	0805		CC20B1E823K or GRM40B823K25
C99	Electrolytic	47 μF	16 V	±20%			16UTSS470M or SM16V470M
C100	Ceramic	0.001 μF	50 V	±5%	0805		CC20SL1H102J
C101	Tantalum	0.1 μF	35 V	±20%			DN1V0R1M1S
C102	Ceramic	0.01 μF	50 V	±10%	0805		CC20B1H103K
C103	Ceramic	8 pF	50 V	±0.5 pF	0805		CC20SL1H080D
C104	Ceramic	470 pF	50 V	±10%	0805		CC20SL1H471K
C105	Ceramic	470 pF	50 V	±10%	0805		CC20SL1H471K
C106	Ceramic	0.0033 μF	50 V	±10%	0805		CC20B1H332K
C107	Ceramic	0.0022 μF	50 V	±10%	0805		CC20B1H222K
C108	Ceramic	0.015 μF	50 V	±10%	0805		CC20B1H153K
C109	Ceramic	0.001 μF	50 V	±5%	0805		CC20SL1H102J
C110	Ceramic	0.082 μF	25 V	±10%	0805		CC20B1E823K or GRM40B823K25
C111	Ceramic	0.001 μF	50 V	±5%	0805		CC20SL1H102J
C112	Electrolytic	10 μF	16 V	±20%			16UTCM100M or SMB16V100M
C113	Ceramic	0.01 μF	50 V	±10%	0805		CC20B1H103K
C114	Ceramic	0.082 μF	25 V	±10%	0805		CC20B1E823K or GRM40B823K25
C115	Electrolytic	1 μF	50 V	±20%			50UTCM010M or SMB50V010M
C116	Ceramic	0.001 μF	50 V	±5%	0805		CC20SL1H102J
C117	Tantalum	33 μF	10 V	±20%			DN1A330M1S
C118	Mylar	0.047 μF	50 V	±10%			NNM-473K
C119	Ceramic	0.082 μF	25 V	±10%	0805		CC20B1E823K or GRM40B823K25
C120	Electrolytic	1 μF	50 V	±20%			50UTSS010M or SM50V010M
C121	Ceramic	0.0082 μF	50 V	±10%	0805		CC20B1H822K
C122	Ceramic	100 pF	50 V	±10%	0805		CC20SL1H101K
C123	Ceramic	0.001 μF	50 V	±5%	0805		CC20SL1H102J
C124	Ceramic	0.082 μF	25 V	±10%	0805		CC20B1E823K or GRM40B823K25
C125	Ceramic	0.001 μF	50 V	±5%	0805		CC20SL1H102J
C126	Ceramic	0.001 μF	50 V	±5%	0805		CC20SL1H102J
C127	Ceramic	0.001 μF	50 V	±5%	0805		CC20SL1H102J
C128	Ceramic	0.001 μF	50 V	±5%	0805		CC20SL1H102J
C129	Ceramic	0.001 μF	50 V	±5%	0805		CC20SL1H102J
C130	Ceramic	0.001 μF	50 V	±5%	0805		CC20SL1H102J
C131	Ceramic	100 pF	50 V	±10%	0805		CC20SL1H101K
C132	Ceramic	100 pF	50 V	±10%	0805		CC20SL1H101K
C133	Ceramic	100 pF	50 V	±10%	0805		CC20SL1H101K

Ref. No.	Description					RS Part No.	Mfr's Part No.
C134	Ceramic	100 pF	50 V	±10%	0805		CC20SL1H101K
C135	Ceramic	0.082 μF	25 V	±10%	0805		CC20B1E823K or GRM40B823K25
C136	Electrolytic	0.022 F	5.5 V	+80%-20%			AC310-G223Z5R5
C137	Ceramic	0.001 μF	50 V	±5%	0805		CC20SL1H102J
C138	Ceramic	0.001 μF	50 V	±5%	0805		CC20SL1H102J
C139	Ceramic	0.001 μF	50 V	±5%	0805		CC20SL1H102J
C140	Ceramic	0.001 μF	50 V	±5%	0805		CC20SL1H102J
C141	Ceramic	0.001 μF	50 V	±5%	0805		CC20SL1H102J
C142	Ceramic	0.001 μF	50 V	±5%	0805		CC20SL1H102J
C143	Ceramic	0.001 μF	50 V	±5%	0805		CC20SL1H102J
C144	Ceramic	0.001 μF	50 V	±5%	0805		CC20SL1H102J
C145	Ceramic	0.001 μF	50 V	±5%	0805		CC20SL1H102J
C146	Ceramic	0.001 μF	50 V	±5%	0805		CC20SL1H102J
C147	Ceramic	0.001 μF	50 V	±5%	0805		CC20SL1H102J
C148	Ceramic	0.001 μF	50 V	±5%	0805		CC20SL1H102J
C149	Ceramic	0.001 μF	50 V	+5%	0805		CC20SL1H102J
C150	Ceramic	0.001 μF	50 V	±5%	0805		CC20SL1H102J
C151	Ceramic	0.001 μF	50 V	±5%	0805		CC20SL1H102J
C152	Ceramic	0.001 μF	50 V	±5%	0805		CC20SL1H102J
C153	Ceramic	0.001 μF	50 V	±5%	0805		CC20SL1H102J
C154	Ceramic	0.001 μF	50 V	±5%	0805		CC20SL1H102J
C155	Ceramic	0.001 μF	50 V	±5%	0805		CC20SL1H102J
C156	Ceramic	0.001 μF	50 V	±5%	0805		CC20SL1H102J
C157	Ceramic	0.001 μF	50 V	±5%	0805		CC20SL1H102J
C158	Ceramic	0.001 μF	50 V	±5%	0805		CC20SL1H102J
C159	Ceramic	0.001 μF	50 V	±5%	0805		CC20SL1H102J
C160	Ceramic	0.001 μF	50 V	±5%	0805		CC20SL1H102J
C161	Ceramic	0.001 μF	50 V	±5%	0805		CC20SL1H102J
C162	Ceramic	0.001 μF	50 V	±5%	0805		CC20SL1H102J
C163	Ceramic	0.001 μF	50 V	±5%	0805		CC20SL1H102J
C164	Ceramic	0.001 μF	50 V	±5%	0805		CC20SL1H102J
C165	Ceramic	0.001 μF	50 V	±5%	0805		CC20SL1H102J
C166	Ceramic	100 pF	50 V	±10%	0805		CC20SL1H101K
C167	Ceramic	100 pF	50 V	±10%	0805		CC20SL1H101K
C168	Ceramic	100 pF	50 V	±10%	0805		CC20SL1H101K
C169	Ceramic	100 pF	50 V	±10%	0805		CC20SL1H101K
C170	Ceramic	100 pF	50 V	±10%	0805		CC20SL1H101K
C171	Ceramic	0.01 μF	50 V	±10%	0805		CC20B1H103K
C172	Electrolytic	4.7 μF	35 V	±20%			35UTSS4R7M or SM35V4R7M
C173	Ceramic	0.082 μF	25 V	±10%	0805		CC20B1E823K or GRM40B823K25
C174	Electrolytic	4.7 μF	35 V	±20%			35UTSS4R7M or SM35V4R7M
C175	Ceramic	100 pF	50 V	+10%	0805		CC20SL1H101K
C176	Ceramic	100 pF	50 V	±10%	0805		CC20SL1H101K
C177	Ceramic	100 pF	50 V	+10%	0805		CC20SL1H101K
C178	Ceramic	100 pF	50 V	±10%	0805		CC20SL1H101K
C179	Ceramic	100 pF	50 V	±10%	0805		CC20SL1H101K

Ref. No.	Description					RS Part No.	Mfr's Part No.
C180	Ceramic	100 pF	50 V	±10%	0805		CC20SL1H101K
C181	Ceramic	100 pF	50 V	±10%	0805		CC20SL1H101K
C182	Ceramic	100 pF	50 V	±10%	0805		CC20SL1H101K
C183	Electrolytic	33 μF	16 V	±20%			16UTSS330M or SM16V330M
C184	Electrolytic	0.22 μF	50 V	±20%			50UTCMR22M or SMB50VR22M
C185	Electrolytic	4.7 μF	35 V	±20%			35UTSS4R7M or SM35V4R7M
C186	Electrolytic	10 μF	16 V	±20%			16UTSS100M or SM16V100M
C187	Ceramic	0.01 μF	50 V	±10%	0805		CC20B1H103K
C188	Ceramic	880 pF	50 V	±10%	0805		CC20SL1H681K
C189	Ceramic	0.01 μF	50 V	±10%	0805		CC20B1H103K
C190	Ceramic	0.01 μF	50 V	±10%	0805		CC20B1H103K
C191	Ceramic	0.0047 μF	50 V	±10%	0805		CC20B1H472K
C192	Electrolytic	10 μF	16 V	±20%			16UTSS100M or SM16V100M
C193	Electrolytic	10 μF	16 V	±20%			16UTSS100M or SM16V100M
C194	Electrolytic	47 μF	16 V	±20%			16UTSS470M or SM16V470M
△ C195	Electrolytic	1000 μF	16 V	±20%			16UTES102M or SM16V102M
C196	Mylar	0.1 μF	50 V	±10%			NNM-104K
C197	Electrolytic	47 μF	16 V	±20%			16UTSS470M or SM16V470M
C198	Ceramic	0.082 μF	25 V	±10%	0805		CC20B1EB23K or GRM40B823K25
C199	Electrolytic	47 μF	16 V	±20%			16UTSS470M or SM16V470M
C200	Electrolytic	1 μF	50 V	±20%			50UTSS010M or SM50V010M
C201	Electrolytic	1 μF	50 V	±20%			50UTSS010M or SM50V010M
C202	Electrolytic	1 μF	50 V	±20%			50UTSS010M or SM50V010M
△ C203	Electrolytic	1000 μF	25 V	±20%			25UTSS102M or SM25V102M
C204	Electrolytic	10 μF	16 V	±20%			16UTSS100M or SM16V100M
C205	Ceramic	1 pF	50 V	±0.25 pF	0805		CC20SL1H010C
Capacitor Blocks							
CB1	Ceramic	0.01 μF x 2	250 V	+80%-20%			EXR-FS203ZS
CB2	Ceramic	0.01 μF x 2	250 V	+80%-20%			EXR-FS203ZS

Ref. No.	Description	RS Part No.	Mfr's Part No.	
Ceramic Filter				
CF1	455 kHz		CFU455D2	
Ceramic Resonator				
CX1	8 MHz		EFO-V8004B5 or KBR8.0MWSTR	
Diodes				
D1	HVU306A	Marked 3	Silicon Varactor	HVU306A
D2	HVU306A	Marked 3	Silicon Varactor	HVU306A
D3	MA77	Marked 4B	Silicon	MA77
D4	HVU308	Marked 8	Silicon Varactor	HVU308
D5	HSM2693A	Marked B4	Silicon	HSM2693A
D6	HSM2693A	Marked B4	Silicon	HSM2693A
D7	HVU308	Marked 8	Silicon Varactor	HVU308
D8	MA110	Marked 1A	Silicon	MA110
D9	MA77	Marked 4B	Silicon	MA77
D10	MA110	Marked 1A	Silicon	MA110
D11	HVU308	Marked 8	Silicon Varactor	HVU308
D12	HVU306A	Marked 3	Silicon Varactor	HVU306A
D13	HVU306A	Marked 3	Silicon Varactor	HVU306A
D14	HVU308	Marked 8	Silicon Varactor	HVU308
D15	HVU308	Marked 8	Silicon Varactor	HVU308
D16	HVU308	Marked 8	Silicon Varactor	HVU308
D17	HSM2693A	Marked B4	Silicon	HSM2693A
D18	HSM2693A	Marked B4	Silicon	HSM2693A
D19	HVU308	Marked 8	Silicon Varactor	HVU308
D20	MA121	Marked M2D	Silicon	MA121
D21	MA121	Marked M2D	Silicon	MA121
D22	HZ18-2L	Zener	Silicon	HZ18-2L
D23	SD-103	Schottky Barrier	Silicon	SD-103
D24	MA728	Marked 2A	Silicon	MA728
D25	MA728	Marked 2A	Silicon	MA728
D26	MA141WA	Marked MN	Silicon	MA141WA
D27	MA141WK	Marked MT	Silicon	MA141WK
D28	1SS272 or 1SS306	Marked A1 Marked A3	Silicon	1SS272 or 1SS306
△ D29	RS102	Rectifier	Silicon	RS102
D30	HZ7A1L	Zener	Silicon	HZ7A1L
D31	MA121	Marked M2D	Silicon	MA121
D32	MA121	Marked M2D	Silicon	MA121
D33	MA121	Marked M2D	Silicon	MA121
D34	Not Used			MA121
D35	MA110	Marked 1A	Silicon	MA110

Ref. No.	Description	RS Part No.	Mfr's Part No.
D36 D37	MA110 Marked 1A Silicon Not Used		MA110
ICs			
IC1	MB1512PFV-G-BND-EF PLL CMOS SMT		MB1512PFV-G-BND-EF
IC2	MC3361N IF Amp./Osc./Mixer/Noise Amp./Quad. Bipolar		MC3361N
IC3	TC4066BF Switch/Zeromatic CMOS SMT		TC4066BF
IC4	BA10358F Zeromatic Bipolar SMT		BA10358F
IC5	or NJM2904G LC3517BM-15 or 12 or 10 16 kbit SRAM		LC3517BM-15 or 12 or 10
	or LC3517BML-15 or 12 or 10 CMOS SMT		or LC3517BML-15 or 12 or 10
IC6	GRE-9109 Microprocessor 4 bit CMOS SMT		GRE-9109
IC7	TDA1905 Audio Amp. Bipolar		TDA1905
IC8	MC7805CT Voltage Regulator Bipolar or L7805CV		MC7805CT or L7805CV
IC9	TA78L005AP Voltage Regulator Bipolar		TA78L005AP
IC10	TK11806M DC-DC Conv. Bipolar SMT		TK11806M
Coils			
L1	Choke		4LNC-092
L2	Choke		4LNC-122
L3	RF (UHF Lo)		GE-88D-7616
L4	Choke		4LNC-122
L5	RF (UHF Lo)		GE-88D-7616
L6	Choke 0.22 μ H		LAL02NAR22K
L7	Tripler		GE-88D-7616
L8	Choke 0.22 μ H		LAL02NAR22K
L9	RF (UHF Hi)		GE-87D-7120
L10	RF (UHF Hi)		GE-87D-7120
L11	Choke		2LNB-253
L12	RF (UHF Hi)		GE-87D-7120
L13	VCO (UHF Hi)		2LNE-314
L14	Doubler		GE-87D-7120
L15	Choke 10 μ H		LAL02NA100K
L16	Choke 10 μ H		LAL02NA100K

Ref. No.	Description					RS Part No.	Mfr's Part No.
Transistors							
Q1	3SK131	Marked	V11	FET	MOS		3SK131
Q2	2SC2712(Y)	Marked	LY	NPN			2SC2712(Y)
Q3	3SK131	Marked	V11	FET	MOS		3SK131
Q4	2SC4226	Marked	R25	NPN			2SC4226
Q5	2SC4226	Marked	R25	NPN			2SC4226
Q6	2SC2714(O)	Marked	QO	NPN			2SC2714(O)
Q7	UN2214	Marked	8D	NPN			UN2214
Q8	2SC2714(O)	Marked	QO	NPN			2SC2714(O)
Q9	2SC2714(O)	Marked	QO	NPN			2SC2714(O)
Q10	UN2214	Marked	8D	NPN			UN2214
Q11	2SC4226	Marked	R25	NPN			2SC4226
Q12	UN2111	Marked	6A	PNP			UN2111
Q13	XN1111	Marked	9S	PNP			XN1111
Q14	XN1111	Marked	9S	PNP			XN1111
Q15	2SC4226	Marked	R25	NPN			2SC4226
Q16	2SC4226	Marked	R25	NPN			2SC4226
Q17	2SC4226	Marked	R25	NPN			2SC4226
Q18	2SC4226	Marked	R25	NPN			2SC4226
Q19	UN2214	Marked	8D	NPN			UN2214
Q20	2SC4226	Marked	R25	NPN			2SC4226
Q21	2SA1162(Y)	Marked	SY	PNP			2SA1162(Y)
Q22	2SC2712(Y)	Marked	LY	NPN			2SC2712(Y)
Q23	2SC2714(O)	Marked	QO	NPN			2SC2714(O)
Q24	2SC2712(O)	Marked	LO	NPN			2SC2712(O)
Q25	2SC2712(O)	Marked	LO	NPN			2SC2712(O)
Q26	UN2214	Marked	8D	NPN			UN2214
Q27	2SC2712(GR)	Marked	LG	NPN			2SC2712(GR)
Q28	2SC2712(GR)	Marked	LG	NPN			2SC2712(GR)
Resistors							
R1	Metal Glaze	100 ohm	1/10 W ±5%	0805			RCM101J50 or ERJ-6GEYJ101
R2	Metal Glaze	100 kohm	1/10 W ±5%	0805			RCM104J50 or ERJ-6GEYJ104
R3	Metal Glaze	100 ohm	1/10 W ±5%	0805			RCM101J50 or ERJ-6GEYJ101
R4	Metal Glaze	22 kohm	1/10 W ±5%	0805			RCM223J50 or ERJ-6GEYJ223
R5	Metal Glaze	100 kohm	1/10 W ±5%	0805			RCM104J50 or ERJ-6GEYJ104
R6	Metal Glaze	22 kohm	1/10 W ±5%	0805			RCM223J50 or ERJ-6GEYJ223
R7	Metal Glaze	100 ohm	1/10 W ±5%	0805			RCM101J50 or ERJ-6GEYJ101
R8	Metal Glaze	100 ohm	1/10 W ±5%	0805			RCM101J50 or ERJ-6GEYJ101

Ref. No.	Description	RS Part No.	Mfr's Part No.
R9	Metal Glaze 47 kohm 1/10 W $\pm 5\%$ 0805		RCM473J50 or ERJ-6GEYJ473
R10	Metal Glaze 4.7 kohm 1/10 W $\pm 5\%$ 0805		RCM472J50 or ERJ-6GEYJ472
R11	Metal Glaze 47 kohm 1/10 W $\pm 5\%$ 0805		RCM473J50 or ERJ-6GEYJ473
R12	Metal Glaze 47 kohm 1/10 W $\pm 5\%$ 0805		RCM473J50 or ERJ-6GEYJ473
R13	Metal Glaze 47 kohm 1/10 W $\pm 5\%$ 0805		RCM473J50 or ERJ-6GEYJ473
R14	Metal Glaze 100 kohm 1/10 W $\pm 5\%$ 0805		RCM104J50 or ERJ-6GEYJ104
R15	Metal Glaze 220 ohm 1/10 W $\pm 5\%$ 0805		RCM221J50 or ERJ-6GEYJ221
R16	Metal Glaze 10 ohm 1/10 W $\pm 5\%$ 0805		RCM100J50 or ERJ-6GEYJ100
R17	Metal Glaze 10 ohm 1/10 W $\pm 5\%$ 0805		RCM100J50 or ERJ-6GEYJ100
R18	Metal Glaze 100 kohm 1/10 W $\pm 5\%$ 0805		RCM104J50 or ERJ-6GEYJ104
R19	Metal Glaze 47 kohm 1/10 W $\pm 5\%$ 0805		RCM473J50 or ERJ-6GEYJ473
R20	Metal Glaze 100 ohm 1/10 W $\pm 5\%$ 0805		RCM101J50 or ERJ-6GEYJ101
R21	Metal Glaze 22 kohm 1/10 W $\pm 5\%$ 0805		RCM223J50 or ERJ-6GEYJ223
R22	Metal Glaze 100 ohm 1/10 W $\pm 5\%$ 0805		RCM101J50 or ERJ-6GEYJ101
R23	Metal Glaze 100 kohm 1/10 W $\pm 5\%$ 0805		RCM104J50 or ERJ-6GEYJ104
R24	Metal Glaze 100 kohm 1/10 W $\pm 5\%$ 0805		RCM104J50 or ERJ-6GEYJ104
R25	Metal Glaze 2.2 kohm 1/10 W $\pm 5\%$ 0805		RCM222J50 or ERJ-6GEYJ222
R26	Metal Glaze 10 ohm 1/10 W $\pm 5\%$ 0805		RCM100J50 or ERJ-6GEYJ100
R27	Metal Glaze 1 kohm 1/10 W $\pm 5\%$ 0805		RCM102J50 or ERJ-6GEYJ102
R28	Metal Glaze 470 ohm 1/10 W $\pm 5\%$ 0805		RCM471J50 or ERJ-6GEYJ471
R29	Metal Glaze 10 kohm 1/10 W $\pm 5\%$ 0805		RCM103J50 or ERJ-6GEYJ103
R30	Metal Glaze 10 kohm 1/10 W $\pm 5\%$ 0805		RCM103J50 or ERJ-6GEYJ103
R31	Metal Glaze 100 ohm 1/10 W $\pm 5\%$ 0805		RCM101J50 or ERJ-6GEYJ101
R32	Metal Glaze 100 ohm 1/10 W $\pm 5\%$ 0805		RCM101J50 or ERJ-6GEYJ101
R33	Metal Glaze 47 kohm 1/10 W $\pm 5\%$ 0805		RCM473J50 or ERJ-6GEYJ473

Ref. No.	Description	RS Part No.	Mfr's Part No.
R34	Metal Glaze 1 Mohm 1/10 W ±5% 0805		RCM105J50 or ERJ-6GEYJ105
R35	Metal Glaze 2.2 kohm 1/10 W ±5% 0805		RCM222J50 or ERJ-6GEYJ222
R36	Metal Glaze 47 ohm 1/10 W ±5% 0805		RCM470J50 or ERJ-6GEYJ470
R37	Metal Glaze 22 kohm 1/10 W ±5% 0805		RCM223J50 or ERJ-6GEYJ223
R38	Metal Glaze 10 kohm 1/10 W ±5% 0805		RCM103J50 or ERJ-6GEYJ103
R39	Metal Glaze 10 kohm 1/10 W ±5% 0805		RCM103J50 or ERJ-6GEYJ103
R40	Metal Glaze 15 kohm 1/10 W ±5% 0805		RCM153J50 or ERJ-6GEYJ153
R41	Metal Glaze 1 kohm 1/10 W ±5% 0805		RCM102J50 or ERJ-6GEYJ102
R42	Metal Glaze 470 ohm 1/10 W ±5% 0805		RCM471J50 or ERJ-6GEYJ471
R43	Metal Glaze 100 kohm 1/10 W ±5% 0805		RCM104J50 or ERJ-6GEYJ104
R44	Metal Glaze 100 ohm 1/10 W ±5% 0805		RCM101J50 or ERJ-6GEYJ101
R45	Metal Glaze 100 ohm 1/10 W ±5% 0805		RCM101J50 or ERJ-6GEYJ101
R46	Metal Glaze 33 kohm 1/10 W ±5% 0805		RCM333J50 or ERJ-6GEYJ333
R47	Metal Glaze 22 kohm 1/10 W ±5% 0805		RCM223J50 or ERJ-6GEYJ223
R48	Metal Glaze 15 kohm 1/10 W ±5% 0805		RCM153J50 or ERJ-6GEYJ153
R49	Metal Glaze 1.5 kohm 1/10 W ±5% 0805		RCM152J50 or ERJ-6GEYJ152
R50	Metal Glaze 220 ohm 1/10 W ±5% 0805		RCM221J50 or ERJ-6GEYJ221
R51	Metal Glaze 47 ohm 1/10 W ±5% 0805		RCM470J50 or ERJ-6GEYJ470
R52	Metal Glaze 470 kohm 1/10 W ±5% 0805		RCM474J50 or ERJ-6GEYJ474
R53	Metal Glaze 1 kohm 1/10 W ±5% 0805		RCM102J50 or ERJ-6GEYJ102
R54	Metal Glaze 100 kohm 1/10 W ±5% 0805		RCM104J50 or ERJ-6GEYJ104
R55	Metal Glaze 1 kohm 1/10 W ±5% 0805		RCM102J50 or ERJ-6GEYJ102
R56	Metal Glaze 100 kohm 1/10 W ±5% 0805		RCM104J50 or ERJ-6GEYJ104
R57	Metal Glaze 100 ohm 1/10 W ±5% 0805		RCM101J50 or ERJ-6GEYJ101
R58	Metal Glaze 3.3 kohm 1/10 W ±5% 0805		RCM332J50 or ERJ-6GEYJ332

Ref. No.	Description	RS Part No.	Mfr's Part No.
R59	Metal Glaze 1 kohm	1/10 W ±5% 0805	RCM102J50 or ERJ-6GEYJ102
R60	Metal Glaze 22 kohm	1/10 W ±5% 0805	RCM223J50 or ERJ-6GEYJ223
R61	Metal Glaze 22 kohm	1/10 W ±5% 0805	RCM223J50 or ERJ-6GEYJ223
R62	Metal Glaze 10 kohm	1/10 W ±5% 0805	RCM103J50 or ERJ-6GEYJ103
R63	Metal Glaze 10 kohm	1/10 W ±5% 0805	RCM103J50 or ERJ-6GEYJ103
R64	Metal Glaze 47 ohm	1/10 W ±5% 0805	RCM470J50 or ERJ-6GEYJ470
R65	Metal Glaze 100 ohm	1/10 W ±5% 0805	RCM101J50 or ERJ-6GEYJ101
R66	Metal Glaze 1 Mohm	1/10 W ±5% 0805	RCM105J50 or ERJ-6GEYJ105
R67	Metal Glaze 100 ohm	1/10 W ±5% 0805	RCM101J50 or ERJ-6GEYJ101
R68	Metal Glaze 10 ohm	1/10 W ±5% 0805	RCM100J50 or ERJ-6GEYJ100
R69	Metal Glaze 47 kohm	1/10 W ±5% 0805	RCM473J50 or ERJ-6GEYJ473
R70	Metal Glaze 10 kohm	1/10 W ±5% 0805	RCM103J50 or ERJ-6GEYJ103
R71	Metal Glaze 22 kohm	1/10 W ±5% 0805	RCM223J50 or ERJ-6GEYJ223
R72	Metal Glaze 15 kohm	1/10 W ±5% 0805	RCM153J50 or ERJ-6GEYJ153
R73	Metal Glaze 470 ohm	1/10 W ±5% 0805	RCM471J50 or ERJ-6GEYJ471
R74	Metal Glaze 100 ohm	1/10 W ±5% 0805	RCM101J50 or ERJ-6GEYJ101
R75	Metal Glaze 47 ohm	1/10 W ±5% 0805	RCM470J50 or ERJ-6GEYJ470
R76	Metal Glaze 47 ohm	1/10 W ±5% 0805	RCM470J50 or ERJ-6GEYJ470
R77	Metal Glaze 100 kohm	1/10 W ±5% 0805	RCM104J50 or ERJ-6GEYJ104
R78	Metal Glaze 1 kohm	1/10 W ±5% 0805	RCM102J50 or ERJ-6GEYJ102
R79	Metal Glaze 1 kohm	1/10 W ±5% 0805	RCM102J50 or ERJ-6GEYJ102
R80	Metal Glaze 47 kohm	1/10 W ±5% 0805	RCM473J50 or ERJ-6GEYJ473
R81	Metal Glaze 47 kohm	1/10 W ±5% 0805	RCM473J50 or ERJ-6GEYJ473
R82	Metal Glaze 47 kohm	1/10 W ±5% 0805	RCM473J50 or ERJ-6GEYJ473
R83	Metal Glaze 10 kohm	1/10 W ±5% 0805	RCM103J50 or ERJ-6GEYJ103

Ref. No.	Description	RS Part No.	Mfr's Part No.
R84	Metal Glaze 10 kohm 1/10 W $\pm 5\%$ 0805		RCM103J50 or ERJ-6GEYJ103
R85	Metal Glaze 10 kohm 1/10 W $\pm 5\%$ 0805		RCM103J50 or ERJ-6GEYJ103
R86	Metal Glaze 15 kohm 1/10 W $\pm 5\%$ 0805		RCM153J50 or ERJ-6GEYJ153
R87	Metal Glaze 4.7 kohm 1/10 W $\pm 5\%$ 0805		RCM472J50 or ERJ-6GEYJ472
R88	Metal Glaze 1 kohm 1/10 W $\pm 5\%$ 0805		RCM102J50 or ERJ-6GEYJ102
R89	Metal Glaze 1 kohm 1/10 W $\pm 5\%$ 0805		RCM102J50 or ERJ-6GEYJ102
R90	Metal Glaze 10 kohm 1/10 W $\pm 5\%$ 0805		RCM103J50 or ERJ-6GEYJ103
R91	Metal Glaze 100 ohm 1/10 W $\pm 5\%$ 0805		RCM101J50 or ERJ-6GEYJ101
R92	Metal Glaze 3.3 kohm 1/10 W $\pm 5\%$ 0805		RCM332J50 or ERJ-6GEYJ332
R93	Metal Glaze 220 kohm 1/10 W $\pm 5\%$ 0805		RCM224J50 or ERJ-6GEYJ224
R94	Metal Glaze 1 kohm 1/10 W $\pm 5\%$ 0805		RCM102J50 or ERJ-6GEYJ102
R95	Metal Glaze 2.2 kohm 1/10 W $\pm 5\%$ 0805		RCM222J50 or ERJ-6GEYJ222
R96	Metal Glaze 2.2 kohm 1/10 W $\pm 5\%$ 0805		RCM222J50 or ERJ-6GEYJ222
R97	Metal Glaze 47 ohm 1/10 W $\pm 5\%$ 0805		RCM470J50 or ERJ-6GEYJ470
R98	Metal Glaze 10 kohm 1/10 W $\pm 5\%$ 0805		RCM103J50 or ERJ-6GEYJ103
R99	Metal Glaze 3.3 kohm 1/10 W $\pm 5\%$ 0805		RCM332J50 or ERJ-6GEYJ332
R100	Metal Glaze 39 kohm 1/10 W $\pm 5\%$ 0805		RCM393J50 or ERJ-6GEYJ393
R101	Metal Glaze 100 kohm 1/10 W $\pm 5\%$ 0805		RCM104J50 or ERJ-6GEYJ104
R102	Metal Glaze 39 kohm 1/10 W $\pm 5\%$ 0805		RCM393J50 or ERJ-6GEYJ393
R103	Metal Glaze 15 kohm 1/10 W $\pm 5\%$ 0805		RCM153J50 or ERJ-6GEYJ153
R104	Metal Glaze 10 kohm 1/10 W $\pm 5\%$ 0805		RCM103J50 or ERJ-6GEYJ103
R105	Metal Glaze 1 Mohm 1/10 W $\pm 5\%$ 0805		RCM105J50 or ERJ-6GEYJ105
R106	Metal Glaze 1 kohm 1/10 W $\pm 5\%$ 0805		RCM102J50 or ERJ-6GEYJ102
R107	Metal Glaze 10 kohm 1/10 W $\pm 5\%$ 0805		RCM103J50 or ERJ-6GEYJ103
R108	Metal Glaze 10 kohm 1/10 W $\pm 5\%$ 0805		RCM103J50 or ERJ-6GEYJ103

Ref. No.	Description	RS Part No.	Mfr's Part No.
R109	Metal Glaze 470 kohm 1/10 W ±5%	0805	RCM474J50 or ERJ-6GEYJ474
R110	Metal Glaze 100 kohm 1/10 W ±5%	0805	RCM104J50 or ERJ-6GEYJ104
R111	Metal Glaze 47 kohm 1/10 W ±5%	0805	RCM473J50 or ERJ-6GEYJ473
R112	Metal Glaze 10 kohm 1/10 W ±5%	0805	RCM103J50 or ERJ-6GEYJ103
R113	Metal Glaze 4.7 kohm 1/10 W ±5%	0805	RCM472J50 or ERJ-6GEYJ472
R114	Metal Glaze 4.7 kohm 1/10 W ±5%	0805	RCM472J50 or ERJ-6GEYJ472
R115	Metal Glaze 150 kohm 1/10 W ±5%	0805	RCM154J50 or ERJ-6GEYJ154
R116	Metal Glaze 470 ohm 1/10 W ±5%	0805	RCM471J50 or ERJ-6GEYJ471
R117	Metal Glaze 47 kohm 1/10 W ±5%	0805	RCM473J50 or ERJ-6GEYJ473
R118	Metal Glaze 100 ohm 1/10 W ±5%	0805	RCM101J50 or ERJ-6GEYJ101
R119	Metal Glaze 5.6 kohm 1/10 W ±5%	0805	RCM562J50 or ERJ-6GEYJ562
R120	Metal Glaze 180 kohm 1/10 W ±5%	0805	RCM184J50 or ERJ-6GEYJ184
R121	Metal Glaze 47 ohm 1/10 W ±5%	0805	RCM470J50 or ERJ-6GEYJ470
R122	Metal Glaze 100 ohm 1/10 W ±5%	0805	RCM101J50 or ERJ-6GEYJ101
R123	Metal Glaze 10 kohm 1/10 W ±5%	0805	RCM103J50 or ERJ-6GEYJ103
R124	Metal Glaze 4.7 kohm 1/10 W ±5%	0805	RCM472J50 or ERJ-6GEYJ472
R125	Metal Glaze 10 kohm 1/10 W ±5%	0805	RCM103J50 or ERJ-6GEYJ103
R126	Metal Glaze 10 kohm 1/10 W ±5%	0805	RCM103J50 or ERJ-6GEYJ103
R127	Metal Glaze 10 kohm 1/10 W ±5%	0805	RCM103J50 or ERJ-6GEYJ103
R128	Metal Glaze 100 kohm 1/10 W ±5%	0805	RCM104J50 or ERJ-6GEYJ104
R129	Metal Glaze 470 kohm 1/10 W ±5%	0805	RCM474J50 or ERJ-6GEYJ474
R130	Metal Glaze 100 kohm 1/10 W ±5%	0805	RCM104J50 or ERJ-6GEYJ104
R131	Metal Glaze 100 kohm 1/10 W ±5%	0805	RCM104J50 or ERJ-6GEYJ104
R132	Metal Glaze 100 kohm 1/10 W ±5%	0805	RCM104J50 or ERJ-6GEYJ104
R133	Metal Glaze 15 kohm 1/10 W ±5%	0805	RCM153J50 or ERJ-6GEYJ153

Ref. No.	Description	RS Part No.	Mfr's Part No.
R134	Metal Glaze 5.6 kohm 1/10 W ±5% 0805		RCM562J50 or ERJ-6GEYJ562
R135	Metal Glaze 8.2 kohm 1/10 W ±5% 0805		RCM822J50 or ERJ-6GEYJ822
R136	Metal Glaze 8.2 kohm 1/10 W ±5% 0805		RCM822J50 or ERJ-6GEYJ822
R137	Metal Glaze 18 kohm 1/10 W ±5% 0805		RCM183J50 or ERJ-6GEYJ183
R138	Metal Glaze 6.8 kohm 1/10 W ±5% 0805		RCM682J50 or ERJ-6GEYJ682
R139	Metal Glaze 1 Mohm 1/10 W ±5% 0805		RCM105J50 or ERJ-6GEYJ105
R140	Metal Glaze 180 kohm 1/10 W ±5% 0805		RCM184J50 or ERJ-6GEYJ184
R141	Metal Glaze 100 kohm 1/10 W +5% 0805		RCM104J50 or ERJ-6GEYJ104
R142	Metal Glaze 10 kohm 1/10 W ±5% 0805		RCM103J50 or ERJ-6GEYJ103
R143	Metal Glaze 10 kohm 1/10 W ±5% 0805		RCM103J50 or ERJ-6GEYJ103
R144	Metal Glaze 10 kohm 1/10 W ±5% 0805		RCM103J50 or ERJ-6GEYJ103
R145	Metal Glaze 47 kohm 1/10 W ±5% 0805		RCM473J50 or ERJ-6GEYJ473
R146	Metal Glaze 470 ohm 1/10 W +5% 0805		RCM471J50 or ERJ-6GEYJ471
R147	Metal Glaze 1 kohm 1/10 W ±5% 0805		RCM102J50 or ERJ-6GEYJ102
R148	Metal Glaze 10 kohm 1/10 W ±5% 0805		RCM103J50 or ERJ-6GEYJ103
R149	Metal Glaze 100 kohm 1/10 W ±5% 0805		RCM104J50 or ERJ-6GEYJ104
R150	Metal Glaze 1 kohm 1/10 W ±5% 0805		RCM102J50 or ERJ-6GEYJ102
R151	Metal Glaze 1 kohm 1/10 W ±5% 0805		RCM102J50 or ERJ-6GEYJ102
R152	Metal Glaze 1 kohm 1/10 W +5% 0805		RCM102J50 or ERJ-6GEYJ102
R153	Metal Glaze 100 kohm 1/10 W ±5% 0805		RCM104J50 or ERJ-6GEYJ104
R154	Metal Glaze 1 kohm 1/10 W ±5% 0805		RCM102J50 or ERJ-6GEYJ102
R155	Metal Glaze 100 kohm 1/10 W ±5% 0805		RCM104J50 or ERJ-6GEYJ104
R156	Metal Glaze 10 kohm 1/10 W ±5% 0805		RCM103J50 or ERJ-6GEYJ103
R157	Metal Glaze 1 Mohm 1/10 W ±5% 0805		RCM105J50 or ERJ-6GEYJ105
R158	Metal Glaze 100 kohm 1/10 W ±5% 0805		RCM104J50 or ERJ-6GEYJ104

Ref. No.	Description	RS Part No.	Mfr's Part No.
R159	Metal Glaze 47 kohm 1/10 W ±5%	0805	RCM473J50 or ERJ-6GEYJ473
R160	Metal Glaze 47 ohm 1/10 W ±5%	0805	RCM470J50 or ERJ-6GEYJ470J
R161	Metal Glaze 27 ohm 1/10 W ±5%	0805	RCM270J50 or ERJ-6GEYJ270J
R162	Metal Glaze 820 ohm 1/10 W ±5%	0805	RCM821J50 or ERJ-6GEYJ821
R163	Metal Glaze 220 ohm 1/10 W ±5%	0805	RCM221J50 or ERJ-6GEYJ221
R164	Metal Glaze 220 kohm 1/10 W ±5%	0805	RCM224J50 or ERJ-6GEYJ224
R165	Metal Glaze 33 kohm 1/10 W ±5%	0805	RCM333J50 or ERJ-6GEYJ333
R166	Metal Glaze 2.2 kohm 1/10 W ±5%	0805	RCM222J50 or ERJ-6GEYJ222
R167	Metal Glaze 4.7 kohm 1/10 W ±5%	0805	RCM472J50 or ERJ-6GEYJ472
R168	Metal Glaze 1 Mohm 1/10 W ±5%	0805	RCM105J50 or ERJ-6GEYJ105
R169	Metal Glaze 470 ohm 1/10 W ±5%	0805	RCM471J50 or ERJ-6GEY471
R170	Metal Glaze 33 kohm 1/10 W ±5%	0805	RCM333J50 or ERJ-6GEYJ333
R171	Metal Glaze 10 kohm 1/10 W ±5%	0805	RCM103J50 or ERJ-6GEYJ103
R172	Metal Glaze 470 kohm 1/10 W ±5%	0805	RCM474J50 or ERJ-6GEYJ474
R173	Metal Glaze 47 kohm 1/10 W ±5%	0805	RCM473J50 or ERJ-6GEYJ473
R174	Metal Glaze 56 ohm 1/10 W ±5%	0805	RCM560J50 or ERJ-6GEYJ560
△ R175	Metal Glaze 10 kohm 1/10 W ±5%	0805	RCM103J55 or ERJ-6GEYJ103
R176	Metal Film Fuse 10 ohm 1/2 W ±5%		FRN1/2 10 OHMJ
R177	Metal Glaze 100 ohm 1/10 W ±5%	0805	RCM101J50 or ERJ-6GEYJ101
R178	Metal Glaze 2.2 ohm 1/10 W ±5%	0805	RCM2R2J50 or ERJ-6GEYJ2R2
R179	Not Used.		
R180	Metal Glaze 4.7 kohm 1/10 W ±5%	0805	RCM472J50 or ERJ-6GEYJ472
R181	Metal Film Fuse 10 ohm 1/2 W ±5%		FRN1/2 10 OHMJ
△ R182	Metal Film Fuse 10 ohm 1/2 W ±5%		FRN1/2 10 OHMJ
R183	See Page 44.		
R184	Carbon Film 4.7 kohm 1/6 W ±5%		ERD-16TJ472

Ref. No.	Description		RS Part No.	Mfr's Part No.
Resistor Arrays				
RA1	1 kohm x 4	1/16 W ±5%		RCB8C102J0
RA2	1 kohm x 4	1/16 W ±5%		RCB8C102J0
RA3	1 kohm x 4	1/16 W ±5%		RCB8C102J0
RA4	1 kohm x 4	1/16 W ±5%		RCB8C102J0
RA5	1 kohm x 4	1/16 W ±5%		RCB8C102J0
RA6	1 kohm x 4	1/16 W ±5%		RCB8C102J0
RA7	1 kohm x 4	1/16 W ±5%		RCB8C102J0
RA8	1 kohm x 4	1/16 W ±5%		RCB8C102J0
RA9	1 kohm x 4	1/16 W ±5%		RCB8C102J0
RA10	1 kohm x 4	1/16 W ±5%		RCB8C102J0
RA11	1 kohm x 4	1/16 W ±5%		RCB8C102J0
RA12	1 kohm x 4	1/16 W ±5%		RCB8C102J0
RA13	1 kohm x 4	1/16 W ±5%		RCB8C102J0
RA14	47 kohm x 4	1/16 W ±5%		RCB8C473J0
RA15	47 kohm x 4	1/16 W ±5%		RCB8C473J0
Transformers				
T1	RF	(VHF Lo)		7SSR-278
T2	RF	(VHF Lo)		7SSR-336
T3	RF	(Air)		7SSR-294
T4	RF	(VHF Hi)		7SSR-290
T5	RF	(Air)		7SSR-289
T6	RF	(VHF Hi)		7SSR-290
T7	VCO	(VHF Lo)		7SSO-337
T8	VCO	(Air, VHF Hi, UHF Lo)		7SSO-310
T9	IF	(10.7 MHz)		GR-A470033
T10	Det.	(455 kHz)		GR-P4203
T11	IF	(455 kHz)		5SSI-292
T12	Det.	(455 kHz)		5SSI-309
T13	DC-DC Converter			GR-D835
Trimmer Capacitors				
TC1	20 pF			ECR-LA020E12
TC2	10 pF			ECR-LA010A12
TC3	10 pF			ECR-LA010A12
TC4	20 pF			ECR-LA020E12
TC5	30 pF			ECR-LA030E12

Ref. No.	Description	RS Part No.	Mfr's Part No.
Crystals			
X1 X2	6.4 MHz 10.245 MHz		GE-87D-7232 TR49-10.245MHz
Crystal Filter			
XF1	10.7 MHz		TR49-MF-10R
Miscellaneous			
CN1 CN2 CN3 CN4 CN5 ⑰ ⑱ ⑲ J1 PL1 ⑳ ㉑ ㉒ TP1 TP2 TP3 TP4 TP5 TP6 TP7 GND ㉓ ㉔ ㉕ ㉖ ㉗ ㉘ ㉙ ㉚ ㉛ SW1 ㉜	Connector, 3 Pin Male Connector, 4 Pin Male Connector, 2 Pin Male Connector, 3 Pin Male Connector, 2 Pin Male Film, Spread Optical Holder, Connector Antenna Holder, LCD Jack, Antenna Lamp, 6 V 35 mA LCD Nut Lock Washer, Inner Pin, Test Pin, Test Pin, Test Pin, Test Pin, Test Pin, Test Pin, Test Pin, Test Pin, Test Plate, Earth RF Screw, 2.6 x 6 Screw, 2.6 x 6 Screw, 3 x 8 Shield, Logic Bottom Shield, Logic Top Shield, PLL Shield, VCO Bottom Shield, VCO Top Switch, Tact (Reset) Filter, Spread Optical		PI22A03M PI22A04M PI22A02M PI22A03M PI22A02M GE-92D-9682 GE-92D-9521 GE-92C-9517 GE-85D-5383 T1-6V35MA-WT T240228 3 m/m 3 m/m GE-87D-7290 GE-87D-7290 GE-87D-7290 GE-87D-7290 GE-87D-7290 GE-87D-7290 GE-87D-7290 GE-87D-7290 GE-87D-7290 GE-92D-9637 PM2.6x6 (Ni) "P" Tight 2.6x6 PM3x8 (Ni) GE-92D-9636 GE-92D-9635 GE-92D-9638 GE-92D-9639 GE-92D-9634 SKHHP GE-92D-9884
		Panhead Machine W/SW (Ni) Panhead "P" Tight Panhead Machine (Ni)	

SQUELCH PCB ASSEMBLY

Ref. No.	Description	RS Part No.	Mfr's Part No.
③②	Assembly, PCB, Squelch Consists of the following:		GA-92D-9750
POTENTIOMETER			
VR1	Squelch 10 kohm (C)		RK0971110-10KC-15

VOLUME PCB ASSEMBLY

Ref. No.	Description	RS Part No.	Mfr's Part No.
③③	Assembly, PCB, Volume Consists of the following:		GA-92D-9749
POTENTIOMETER			
VR2	Volume W/Switch 50 kohm (A)		RK0971211-50KA-15

MECHANICAL PARTS LIST

Ref. No.	Description	RS Part No.	Mfr's Part No.
①	Antenna, Telescopic		GE-87D-3229
②	Assembly, Case (Non Repairable)		GA-92D-9528
	Case		GE-92A-9515
	Window, LCD		GE-92C-9516
	Label, Model		GE-92D-9677
③	Assembly, Cover, Bottom (Non Repairable)		GA-92D-9755-USA
	Cover, Bottom		GE-92C-9520
	Foot (BLK)		SJ-5027
	Label, Caution		GE-86D-6648
④	Binder, Cord, AC		No.5121 or W-140
⑤	Cord, AC		UP-953-J01
⑥	Holder, Speaker		GE-84D-4580
⑦	Key Top		GE-92D-9519
⑧	Knob, Volume/Squelch		GE-92D-9518
⑨	Lug		GE-85D-6142
⑩	Plate, Ground		GE-92D-9522
⑪	Relief, Strain Cord Line		SR-3L-1
R183	Resistor, Solid	1.8 Mohm 1/2 W ±10%	ERC12GK185
SP1	Speaker	8 ohm 1 W	S08J18
⑫	Terminal		1-SD
△ T14	Transformer, Power		GE-85D-5568V
	Wire Kit		#9109 (A)
	Hardware Kit		#9109 (B)
⑬	Screw, 2.6 x 6	Panhead Machine BLK (Zn)	PM2.6x6 BLK (Zn)
⑭	Screw, 2.6 x 6	Panhead "P" Tight	"P" Tight 2.6x6
⑮	Screw, 4 x 8	Bindinghead "P" Tight	"P" Tight 4x8
⑯	Lock Washer, Outer 4 m/m		
	Binder, Wire		PLT IM-M or BK-1
	Tube, AH-3		AWG 8/16 40mm
	The following parts are used for CANADA model only.		
②	Assembly, Case for CANADA (Non Repairable)		GA-92D-9899
	Case		GE-92A-9515
	Window, LCD		GE-92C-9898
	Label, Model		GE-92D-9779
③	Assembly, Cover, Bottom for CANADA (Non Repairable)		GA-92D-9755-CANADA
	Cover, Bottom		GE-92C-9520
	Foot (BLK)		SJ-5027
	Label, Caution		GE-86D-6650
△ T14	Transformer, Power		Z272B

EXPLODED VIEW

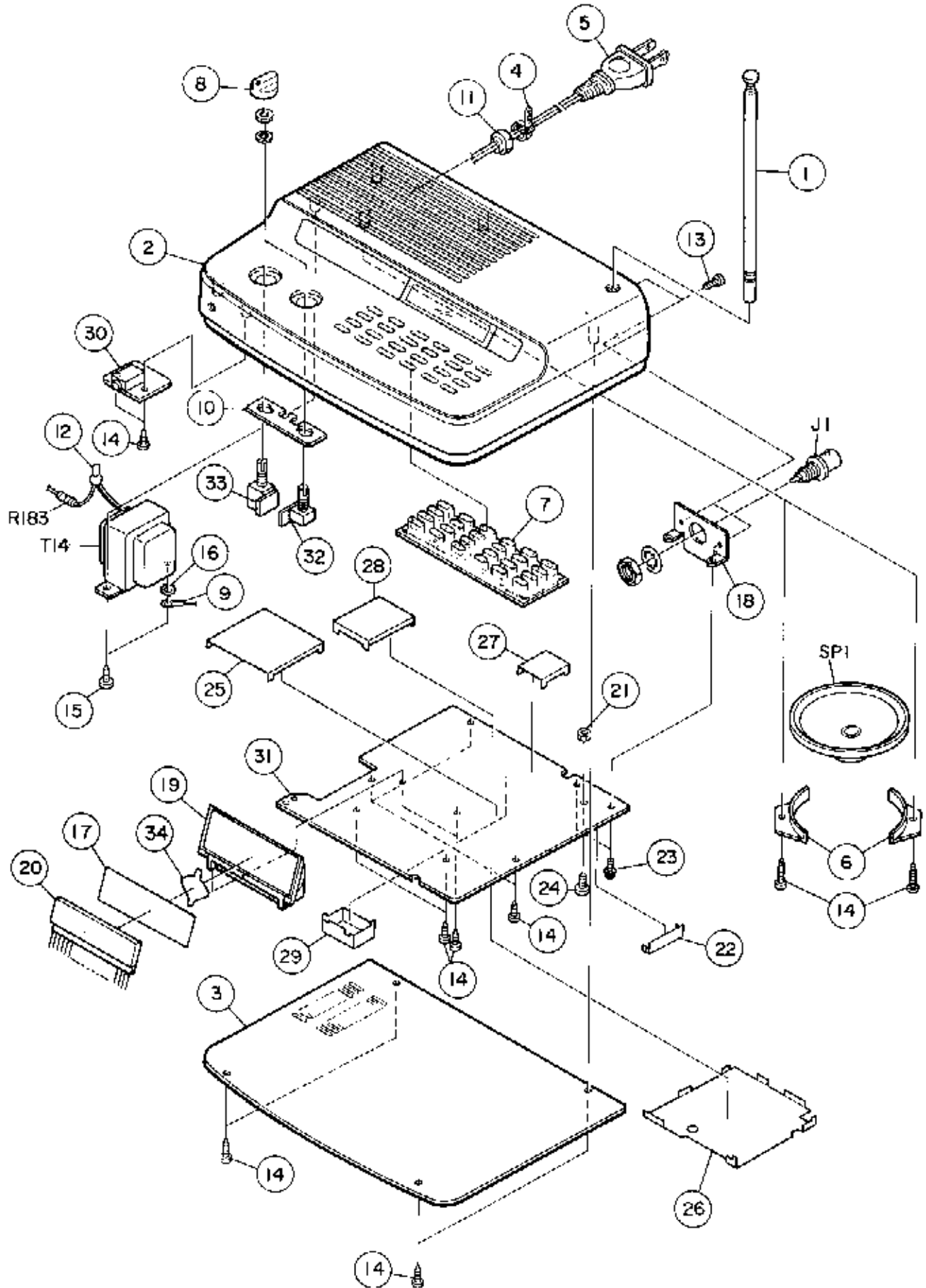

SEMICONDUCTOR LEAD IDENTIFICATION AND IC BLOCK DIAGRAM

INTEGRATED CIRCUIT LEAD IDENTIFICATION

IC1 MB1512PFV-G-BND-EF

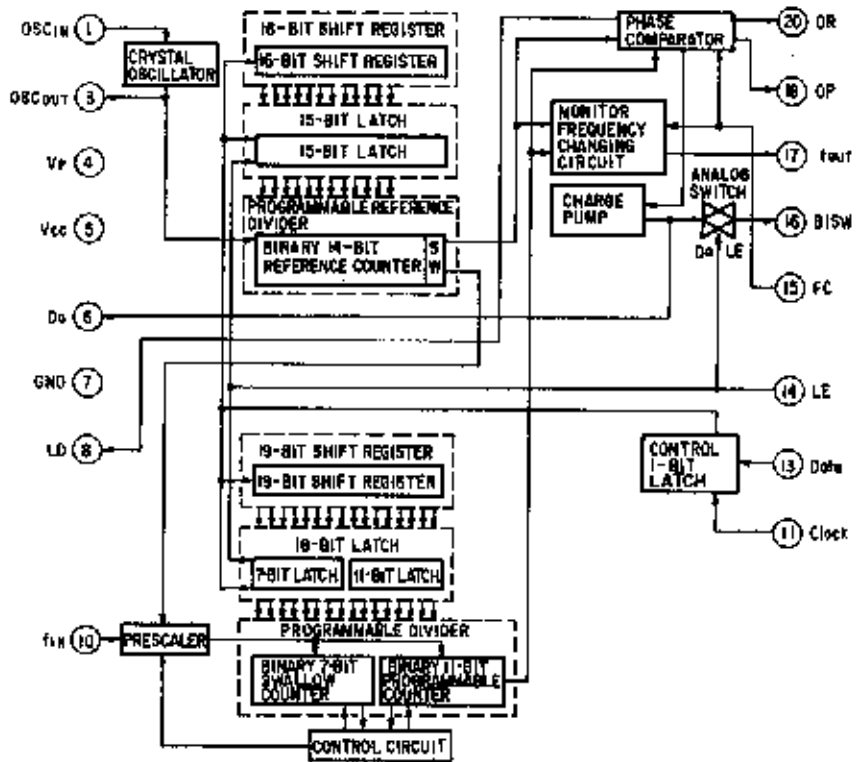
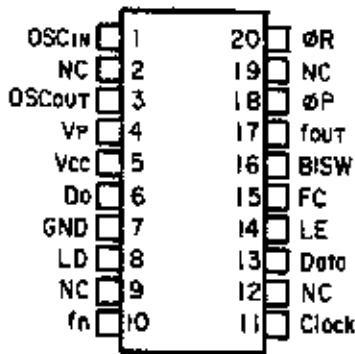

IC2 MC3361N

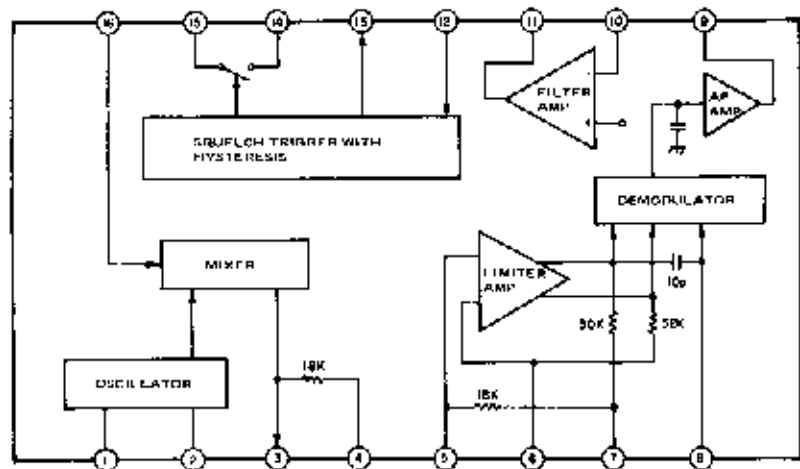
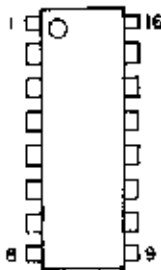

IC3 TC4066BF

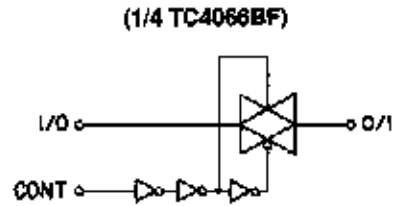
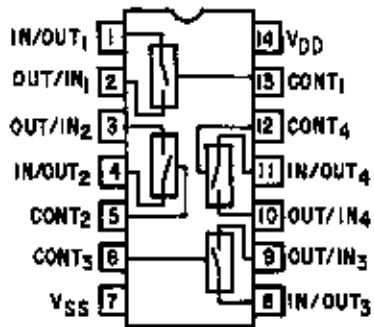

IC4 BA10358F
NJM2904G

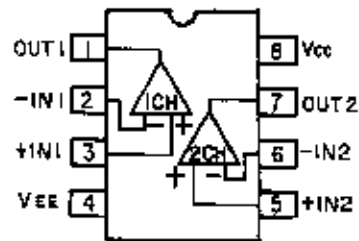
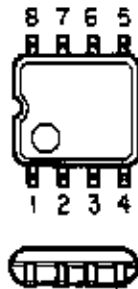

IC5 LC3517BM-15, -12, -10

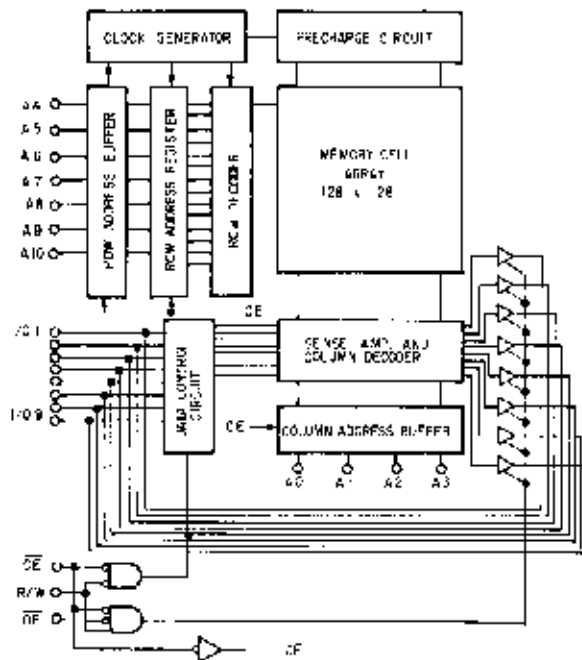
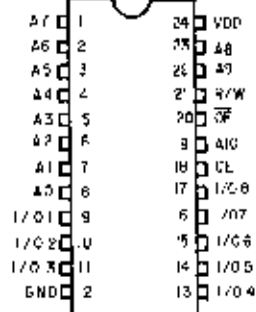

IC6 GRE-9109

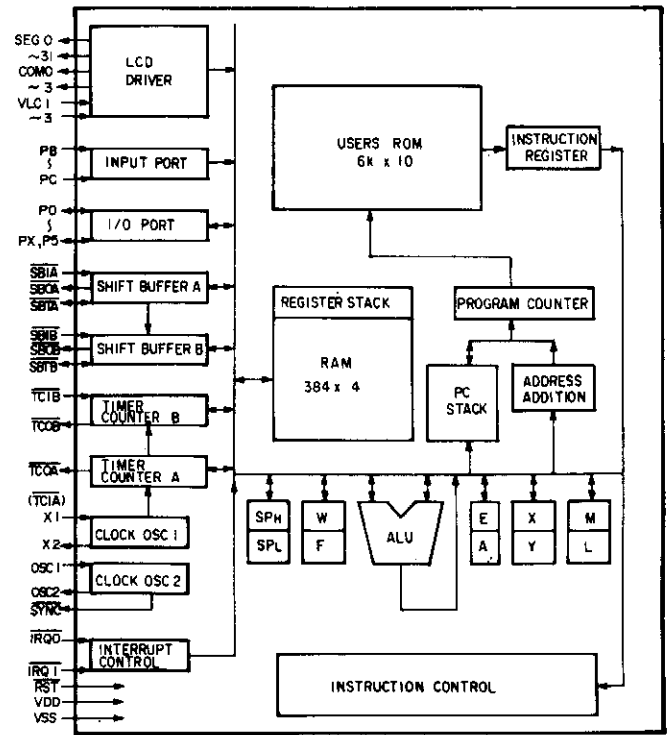
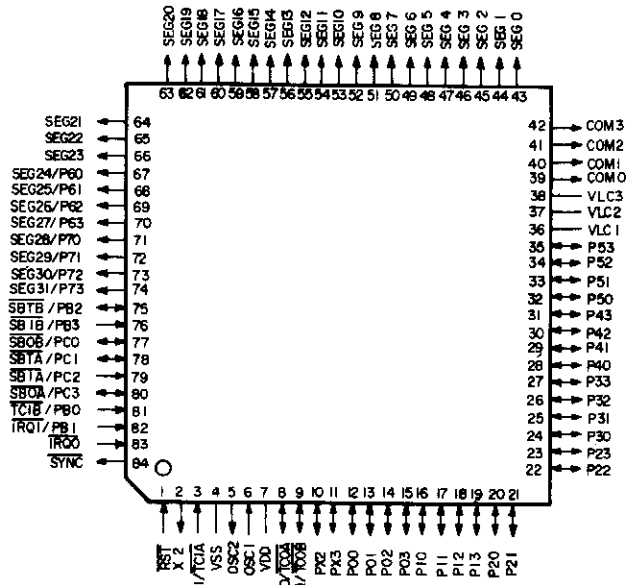

IC7 TDA1905

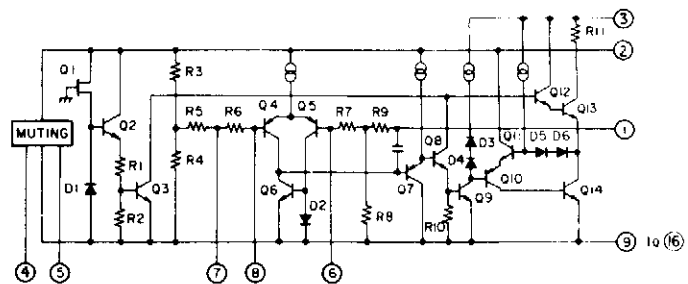
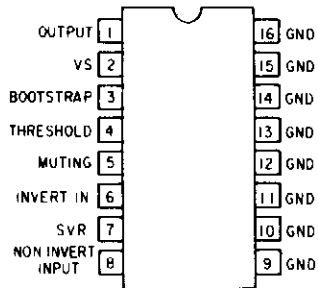

IC8 MC7805CT



- 1. IN
- 2. GND
- 3. OUT

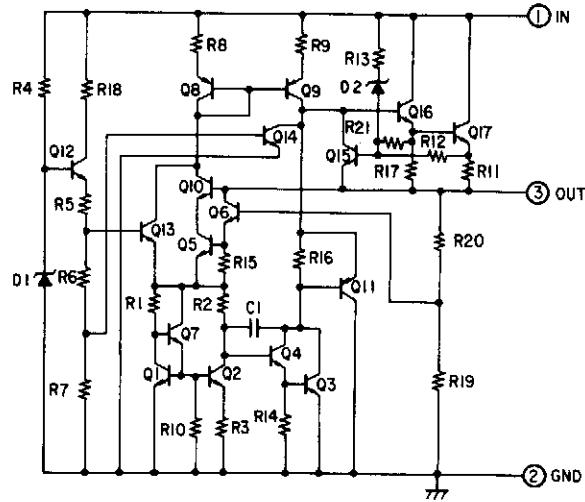

IC9 TA78L005AP

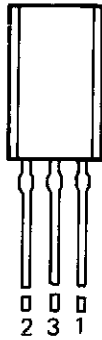

- 1. INPUT
- 2. OUTPUT
- 3. COMMON

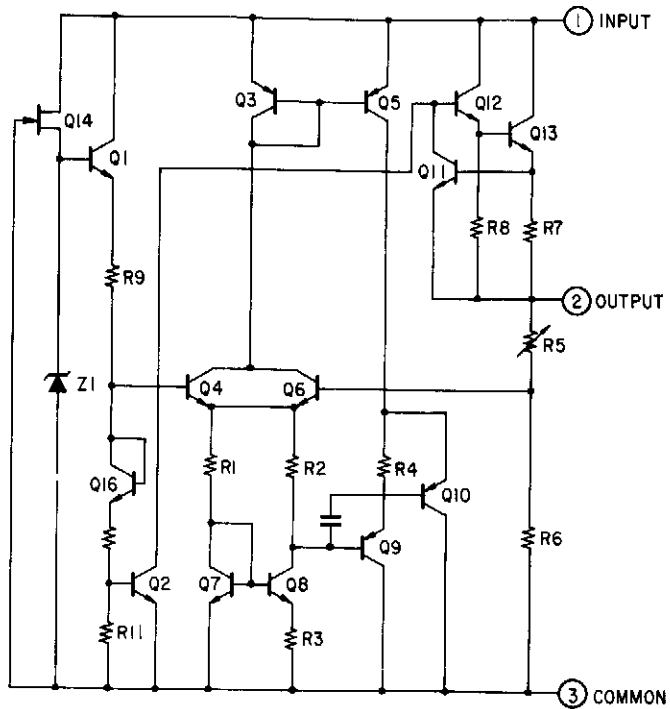

IC10 TK11806M

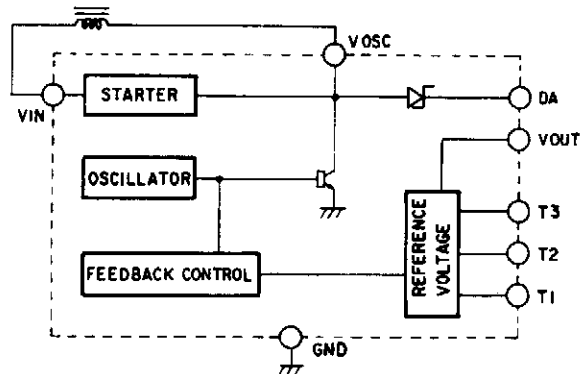
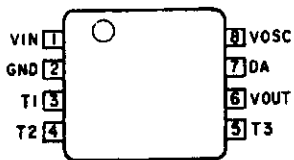

TRANSISTOR LEAD IDENTIFICATION

- (A) 2SC2712 (Y,O,GR) (Marked LY,LO,LG)
 2SC2714 (O) (Marked QO)
 UN2111 (Marked 6A)
 UN2214 (Marked 8D)
 2SA1162 (Y) (Marked SY)

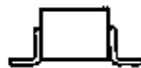
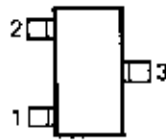

- 1: Emitter
 2: Base
 3: Collector

- (B) 2SC4226 (Marked R25)

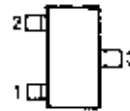

- 1: Emitter
 2: Base
 3: Collector

- (C) 3SK131 (Marked V11)

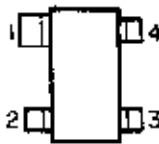

- 1: Gate 1
 2: Gate 2
 3: Drain
 4: Source

- (E) XN1111 (Marked 9S)

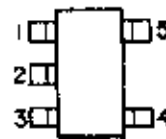

- 1: Base 1 (B1)
 2: Emitter (E)
 3: Base 2 (B2)
 4: Collector 2 (C2)
 5: Collector 1 (C1)

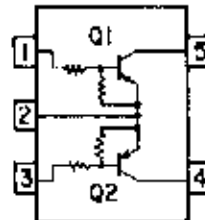

DIODE LEAD IDENTIFICATION

- a) ISS272 (Marked A1)
1SS306 (Marked A3)

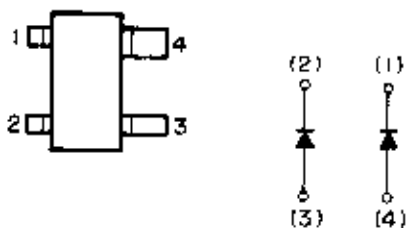

- 1: Cathode 1
2: Cathode 2
3: Anode 2
4: Anode 1

- b) MA77 (Marked 4B)

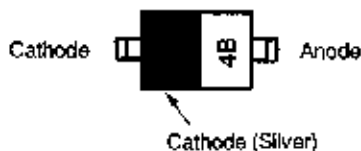

- c) MA110 (Marked 1A)

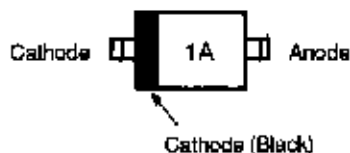

- d) MA121 (Marked M2D)

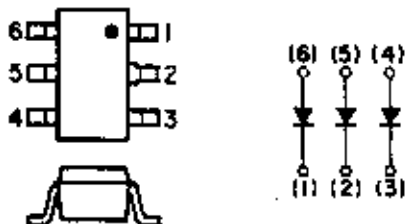

- 1: Cathode 1
2: Cathode 2
3: Cathode 3
4: Anode 3
5: Anode 2
6: Anode 1

- e) MA141 WA (Marked MN)

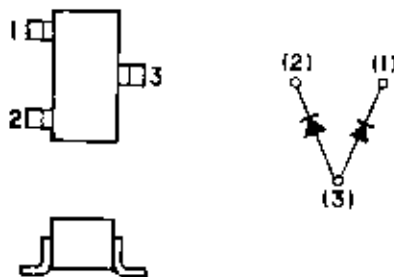

- 1: Cathode 1
2: Cathode 2
3: Anode 1,2

- f) MA141 WK (Marked MT)

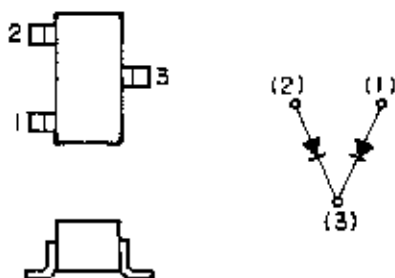

- 1: Anode 1
2: Anode 2
3: Cathode 1,2

g) MA728 (Marked 2A)

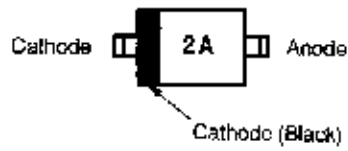

h) HSM2693A (Marked B4)

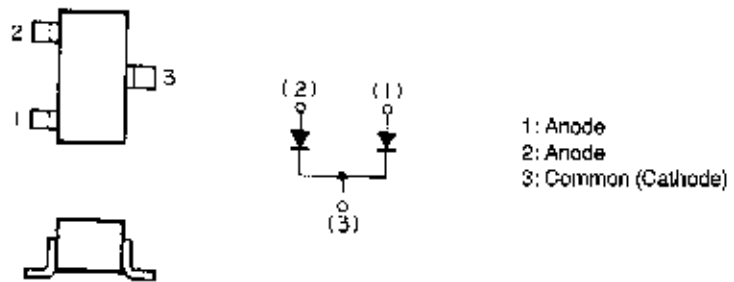

i) HVU306A (Marked 3)

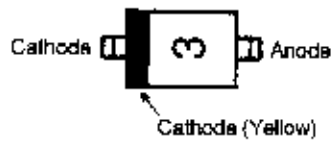

j) HVU308 (Marked 8)

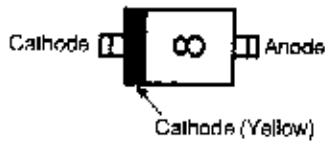

k) HZ7A1L
HZ18-2L

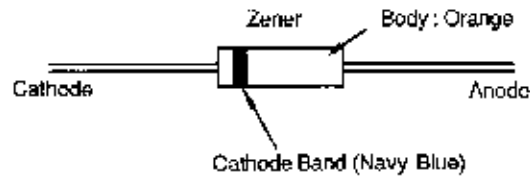

l) RS102

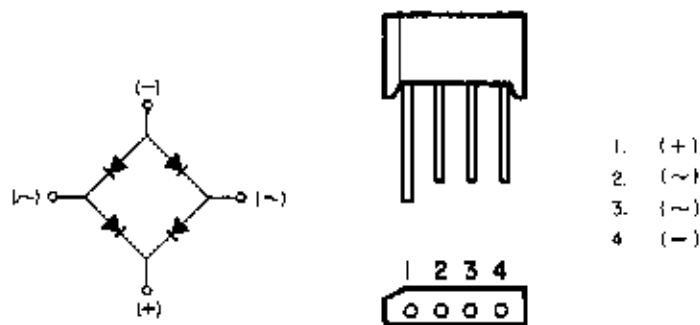

m) SD-103

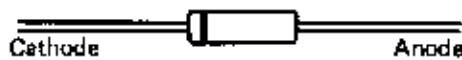

MICROPROCESSOR (IC6) PORT FORMAT

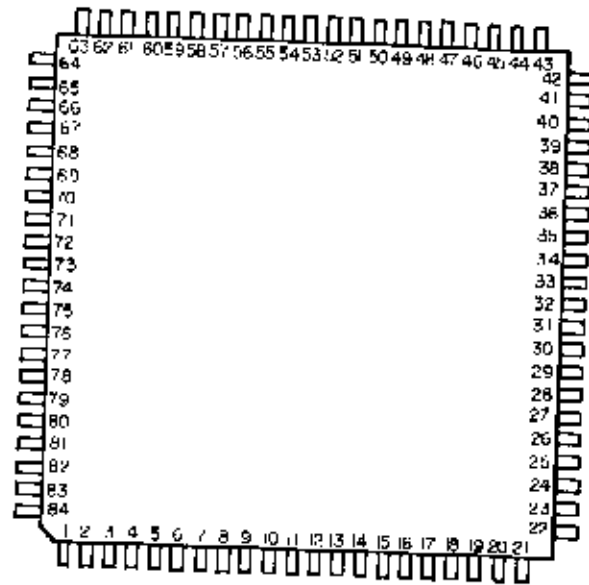

Pin No.		Pin No.	
1	Initialize signal input	43	LCD segment driver output
2	Not used.	44	LCD segment driver output
3	+B	45	LCD segment driver output
4	Yes	46	LCD segment driver output
5	Resonator connection terminal	47	LCD segment driver output
6	Resonator connection terminal	48	LCD segment driver output
7	Vpp	49	LCD segment driver output
8	Not used	50	LCD segment driver output
9	Peop Output	51	LCD segment driver output
10	BAND UHF HI	52	LCD segment driver output
11	BAND UHF LO	53	LCD segment driver output
12	BAND VHF HI	54	LCD segment driver output
13	BAND Air	55	LCD segment driver output
14	BAND VHF LO OR MID	56	LCD segment driver output
15	Switch	57	LCD segment driver output
16	Squelch Input	58	LCD segment driver output
17	Zeromatic input	59	LCD segment driver output
18	Memory R/W output	60	LCD segment driver output
19	Memory OE output	61	LCD segment driver output
20	Memory I/O 1	62	LCD segment driver output
21	Memory I/O 2	63	LCD segment driver output
22	Memory I/O 3	64	LCD segment driver output
23	Memory I/O 4	65	LCD segment driver output
24	Memory address A0	66	LCD segment driver output
25	Memory address A1	67	LCD segment driver output
26	Memory address A2	68	Not used
27	Memory address A3	69	Not used
28	Memory address A4	70	Not used
29	Memory address A5	71	LCD bias control
30	Memory address A6	72	PLL latch output
31	Memory address A7	73	Mute output
32	Memory address A8	74	Not used
33	Memory address A9	75	Key input
34	Memory address A10	76	Key input
35	Memory OE output	77	Band select
36	LCD drive power supply	78	Serial clock output
37	LCD drive power supply	79	SBTA/PCz
38	LCD drive power supply	80	Serial data output
39	LCD common driver output	81	Key Input
40	LCD common driver output	82	HOLD Input
41	LCD common driver output	83	+B
42	LCD common driver output	84	Timing output (Not used)

POWER TRANSFORMER SPECIFICATIONS

U.S.A

Rated primary voltage and frequency

120 V 60 Hz

Open circuit primary current

Less than 65 mA at 120 V 60 Hz

Secondary output voltage

DC 17 V

(No load voltage)

DC 13 V \pm 5% at DC 200 mA

(Rated voltage)

115°C, 250 volts, 1.5 A

Protector

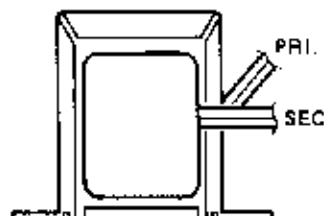
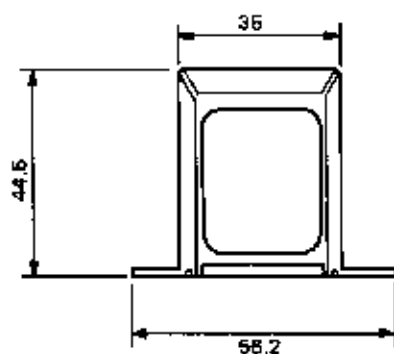
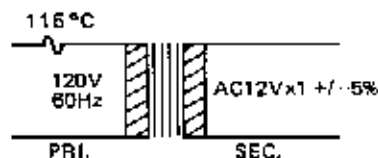
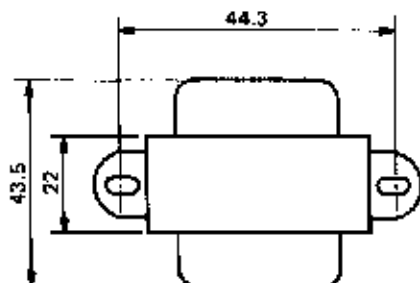

CANADA

Rated primary voltage and frequency

120 V 60 Hz

Open circuit primary current

Less than 55 mA at 120 V 60 Hz

Secondary output voltage

AC 12.7 V

(No load voltage)

AC 11.6 V

(Rated voltage)

133°C, 250 volts, 1.5 A

Protector

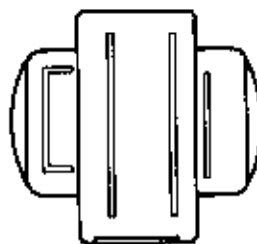
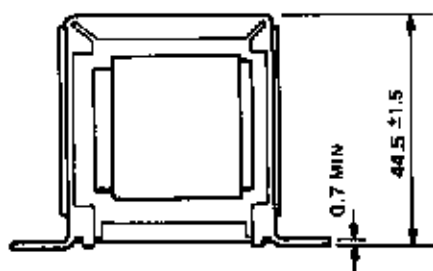
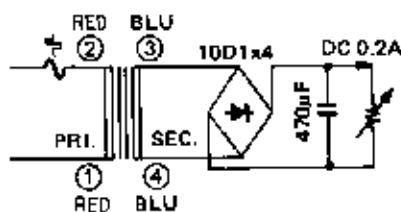
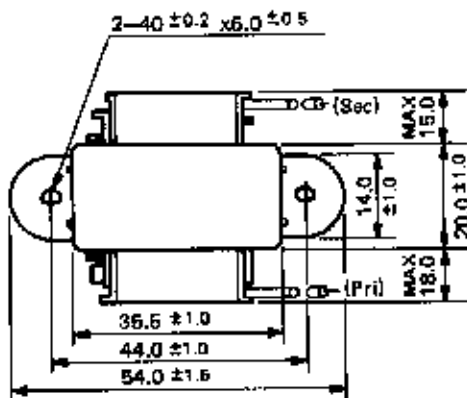

SCHEMATIC DIA

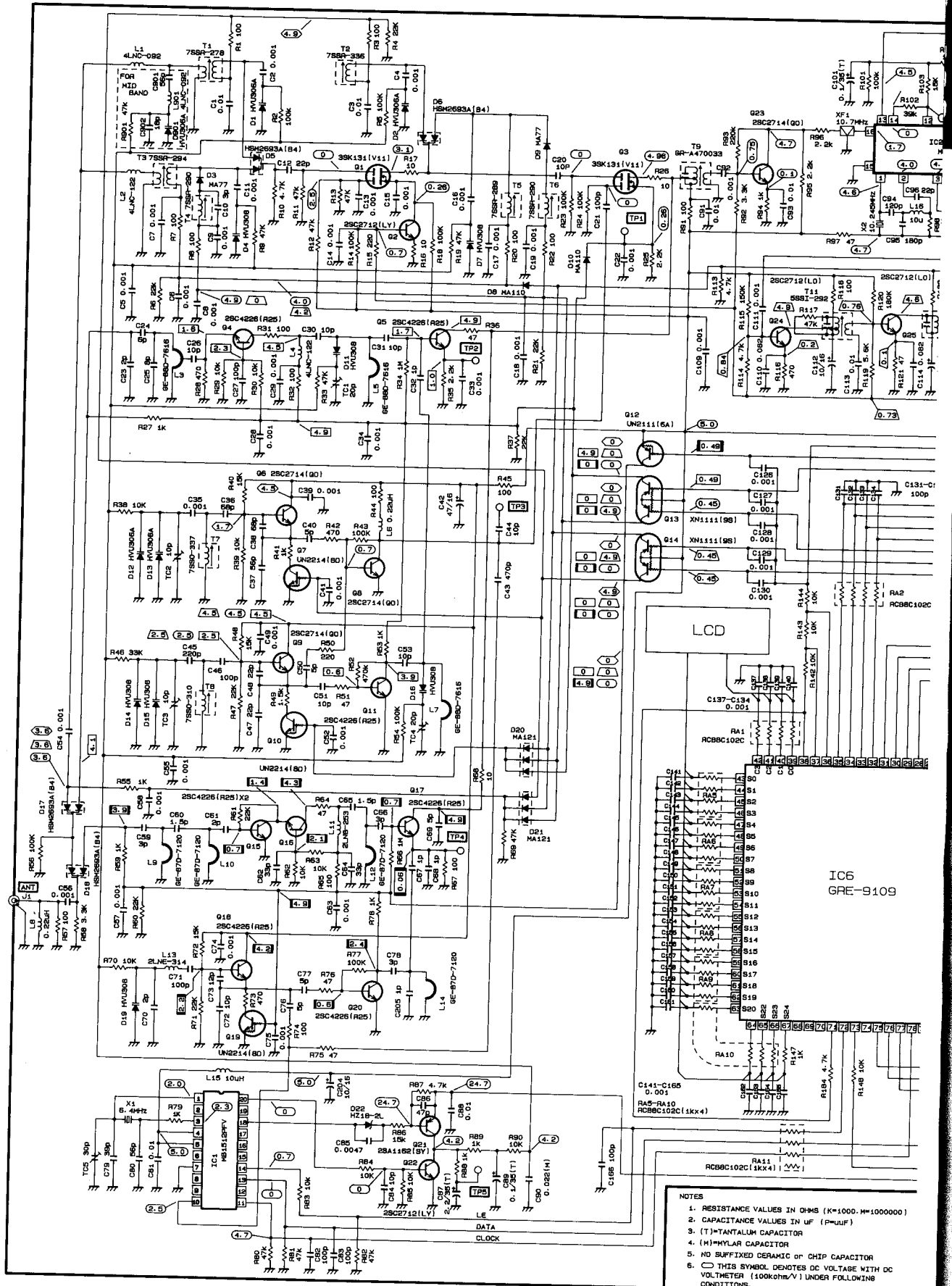

- NOTES
1. RESISTANCE VALUES IN OHMS (K=1000, M=1000000)
 2. CAPACITANCE VALUES IN UF (P=100PF)
 3. (T)=TANTALUM CAPACITOR
 4. (H)=POLAR CAPACITOR
 5. HD SUFFIXED CERAMIC or CHIP CAPACITOR
 6. (V) THIS SYMBOL DENOTES DC VOLTAGE WITH DC VOLTMETER (100KOHM/V) UNDER FOLLOWING CONDITIONS.
CH1 HIGH BAND AT 150MHZ. MANUAL OPERATION.
VOLUME AT MINIMUM AND SQUELCH CDW

GRAM

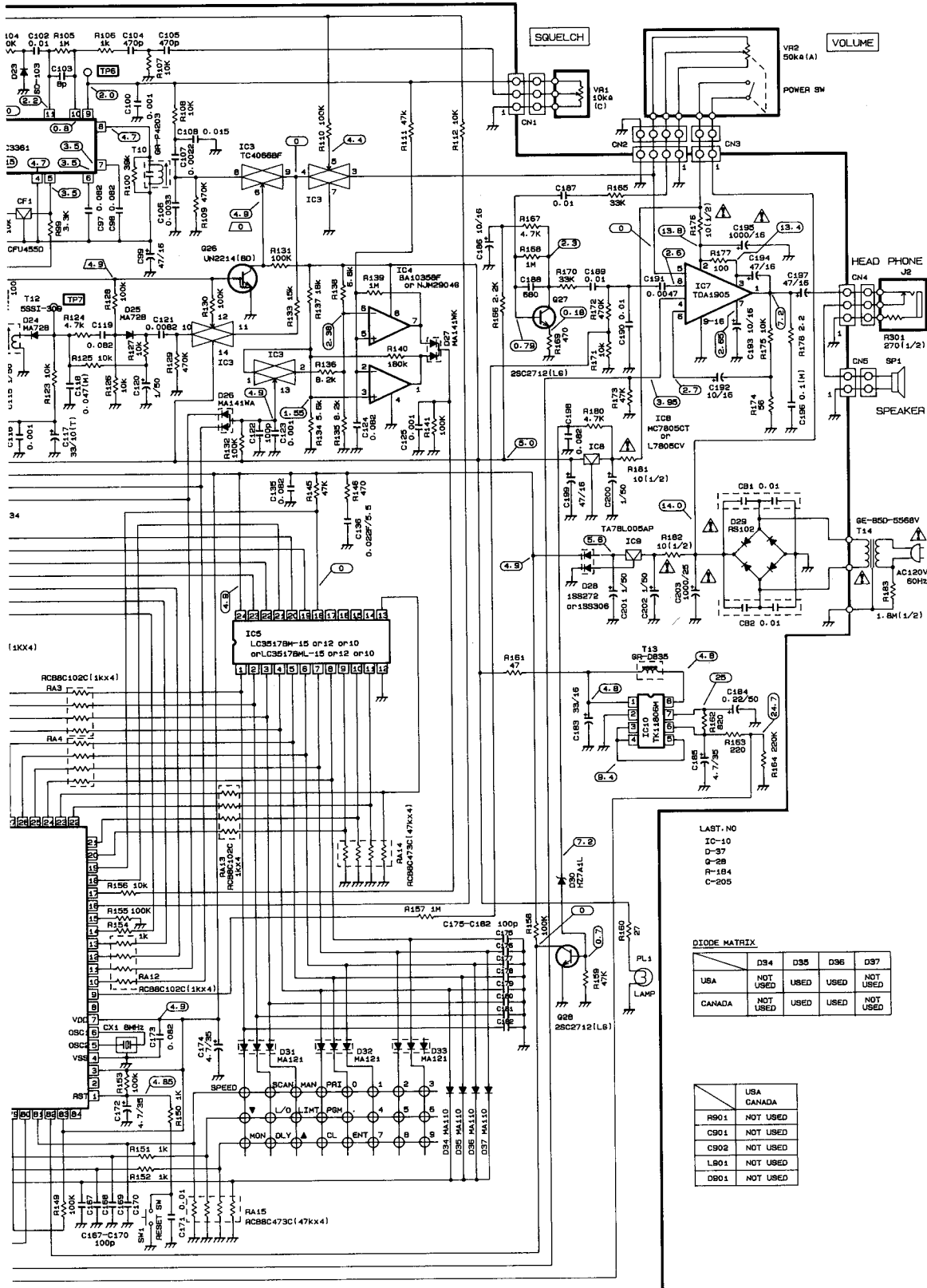

LAST. NO
 IC-10
 D-37
 O-28
 R-184
 C-205

DIODE MATRIX

	D34	D35	D36	D37
USA	NOT USED	USED	USED	NOT USED
CANADA	NOT USED	USED	USED	NOT USED

	USA	CANADA
R901	NOT USED	
C901	NOT USED	
C902	NOT USED	
L901	NOT USED	
D901	NOT USED	

- 7. ○ THIS SYMBOL DENOTES VOLTAGES FOR LOW BAND OPERATION
- 8. □ THIS SYMBOL DENOTES VOLTAGES FOR AIRCRAFT BAND OPERATION
- 9. □ THIS SYMBOL DENOTES VOLTAGES FOR UHF LOW/T BAND OPERATION
- 10. □ THIS SYMBOL DENOTES VOLTAGES FOR UHF HIGH BAND OPERATION

CAUTION
 SINCE THE COMPONENTS MARKED BY ▲ ARE CRITICAL FOR SAFETY,
 USE ONES DESCRIBED ON PARTS LIST ONLY.

